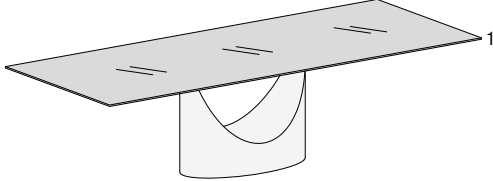
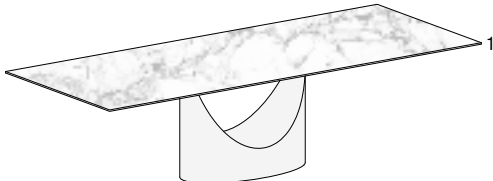
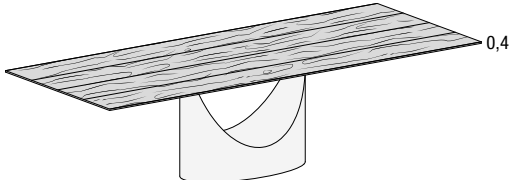
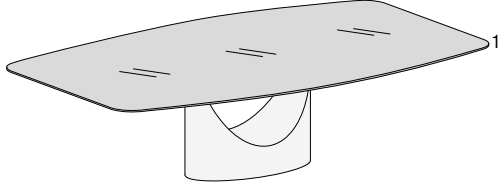
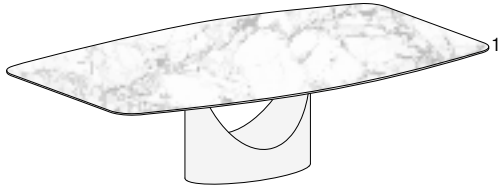
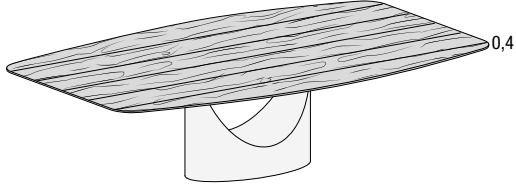

U TABLE

Descrizione/Description	Larghezza Width	Profondità Depth	Altezza Height	Codice Code	Vetro lucido Polished glass	Vetro opaco Matt glass
Tavolo U rettangolare vetro <i>Rectangular glass U table</i> 2490G 						
Top vetro Base in acciaio verniciato Titanio steel o Peltro steel. * Consigliato utilizzo per 6 persone <i>Glass top</i> <i>Steel base painted in Titanio Steel or Peltro Steel.</i> * Recommended for seating 6 people	200	100*	76	TA0103		
	220	110	76	TA0104		
	250	120	76	TA0105		
	300	120	76	TA0106		
Tavolo U rettangolare XGlass <i>Rectangular XGlass U table</i> 2490X 	Larghezza Width	Profondità Depth	Altezza Height	Codice Code	XGlass	
Top XGlass lucido o opaco. Base in acciaio verniciato Titanio steel o Peltro steel. * Consigliato utilizzo per 6 persone <i>Polished or matt XGlass top.</i> <i>Steel base painted in Titanio Steel or Peltro Steel.</i> * Recommended for seating 6 people	200	100*	76	TA0108		
	220	110	76	TA0109		
	250	120	76	TA0110		
	300	120	76	TA0111		
Tavolo U rettangolare Wildwood <i>Rectangular Wildwood U table</i> 2490W 	Larghezza Width	Profondità Depth	Altezza Height	Codice Code	Wildwood	
Top Wildwood. Base in acciaio verniciato Titanio steel o Peltro steel. * Consigliato utilizzo per 6 persone <i>Wildwood top.</i> <i>Steel base painted in Titanio Steel or Peltro Steel.</i> * Recommended for seating 6 people	200	100*	76	TA0113		
	220	110	76	TA0114		
	248	120	76	TA0115		
	298	120	76	TA0116		

U TABLE

Descrizione//Description	Larghezza Width	Profondità Depth	Altezza Height	Codice Code	Vetro lucido Polished glass	Vetro opaco Matt glass
Tavolo U sagomato vetro <i>Shaped glass U table</i> 2495G  Top vetro Base in acciaio verniciato Titanio steel o Peltro steel. <i>Glass top</i> <i>Steel base painted in Titanio Steel or Peltro Steel.</i>						
	200	120	76	TA0121		
	220	120	76	TA0122		
	250	120	76	TA0123		
	300	120	76	TA0142		
Tavolo U sagomato XGlass <i>Shaped XGlass U table</i> 2495X  Top XGlass lucido o opaco. Base in acciaio verniciato Titanio steel o Peltro steel. <i>Polished or matt XGlass top.</i> <i>Steel base painted in Titanio Steel or Peltro Steel.</i>	Larghezza Width	Profondità Depth	Altezza Height	Codice Code	XGlass	
	200	120	76	TA0124		
	220	120	76	TA0125		
	250	120	76	TA0126		
300	120	76	TA0143			
Tavolo U sagomato Wildwood <i>Shaped Wildwood U table</i> 2495W  Top Wildwood. Base in acciaio verniciato Titanio steel o Peltro steel. <i>Wildwood top.</i> <i>Steel base painted in Titanio Steel or Peltro Steel.</i>	Larghezza Width	Profondità Depth	Altezza Height	Codice Code	Wildwood	
	200	120	76	TA0127		
	220	120	76	TA0128		
	248	120	76	TA0129		
298	120	76	TA0144			

U TABLE

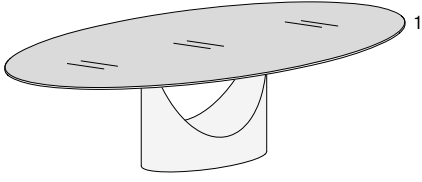
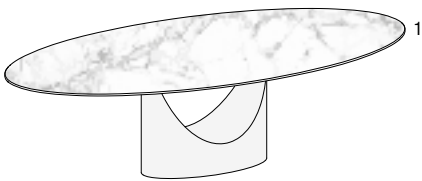
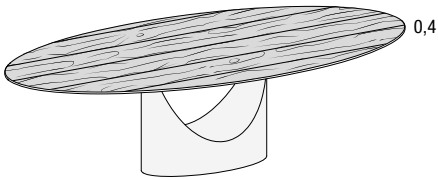
Descrizione/Description	Larghezza Width	Profondità Depth	Altezza Height	Codice Code	Vetro lucido Polished glass	Vetro opaco Matt glass
Tavolo U ovale vetro <i>Oval glass U table</i> 2500G  <p>Top vetro Base in acciaio verniciato Titanio steel o Peltro steel. <i>Glass top</i> <i>Steel base painted in Titanio Steel or Peltro Steel.</i></p>						
	200	130	76	TA0133		
	220	130	76	TA0134		
	250	130	76	TA0135		
	300	130	76	TA0145		
Tavolo U ovale XGlass <i>Oval XGlass U table</i> 2500X  <p>Top XGlass lucido o opaco. Base in acciaio verniciato Titanio steel o Peltro steel. <i>Polished or matt XGlass top.</i> <i>Steel base painted in Titanio Steel or Peltro Steel.</i></p>					XGlass	
	200	130	76	TA0136		
	220	130	76	TA0137		
	250	130	76	TA0138		
	300	130	76	TA0146		
Tavolo U ovale Wildwood <i>Oval Wildwood U table</i> 2500W  <p>Top Wildwood. Base in acciaio verniciato Titanio steel o Peltro steel. <i>Wildwood top.</i> <i>Steel base painted in Titanio Steel or Peltro Steel.</i></p>					Wildwood	
	200	128	76	TA0139		
	220	128	76	TA0140		
	248	128	76	TA0141		
	298	128	76	TA0147		

U TABLE

Basamento in acciaio, verniciato con polveri epossidiche, effetto metallizzato.
Steel base painted with a metallic-effect epoxy powder.

TOP IN WILDWOOD//WILDWOOD TOP

Pannello in multistrato di betulla sp. 1,8 cm, certificato CARB2 / TSCA TITLE VI, accoppiato con pannelli sp.1,8 cm costituiti da un supporto in listellare e uno strato di rovere sp. 0,4 cm.
Birch plywood panel, 1,8 cm thick, certified CARB2 / TSCA TITLE VI, paired with panels, 1,8 cm thick consisting of a blockboard support and a layer of oak, 0,4 cm thick.

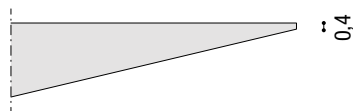

TOP IN VETRO LUCIDO O OPACO//POLISHED OR MATT GLASS TOP

Vetro extra-chiaro temperato sp. 1 cm laccato nei colori LAGO con verniciatura all'acqua, accoppiato ad un vetro temperato sp. 0,8 cm.
Tempered extra-clear glass, 1 cm thick, lacquered in the LAGO colours with water-based paint, paired with tempered glass, 0,8 cm thick.

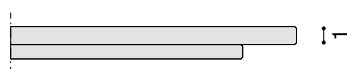

TOP IN XGLASS LUCIDO O OPACO//POLISHED OR MATT XGLASS TOP

Vetro extra-chiaro temperato sp. 1 cm, finito con una verniciatura acrilica UV e retro-verniciatura all'acqua, accoppiato ad un vetro temperato sp. 0,8 cm.
Tempered extra-clear glass, 1 cm thick, finished with a UV acrylic paint and painted on the back with a water-based paint, paired with tempered glass, 0,8 cm thick.

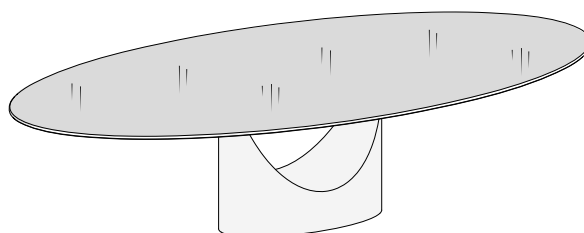
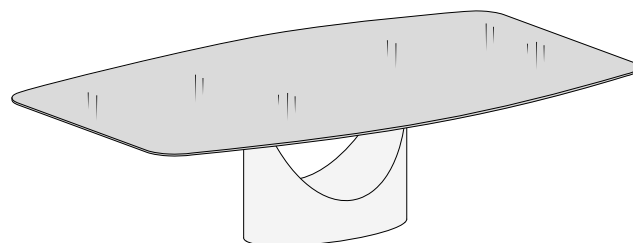
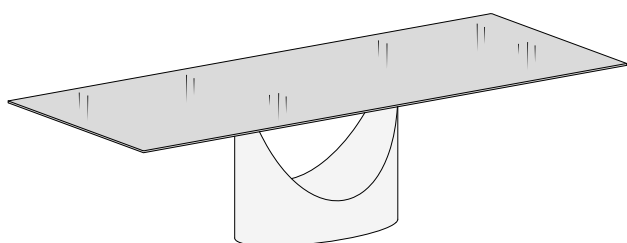
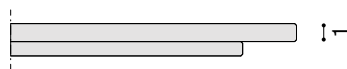

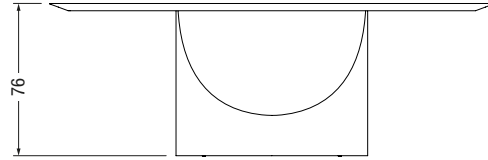

200 x 100

Consigliato utilizzo per 6 persone
Recommended for seating 6 people

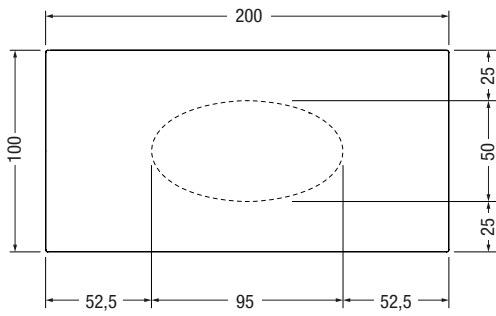

220 x 110

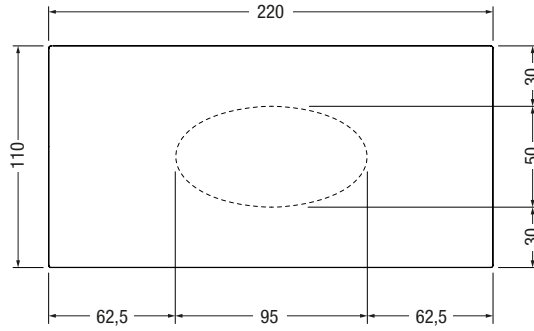

248/250 x 120

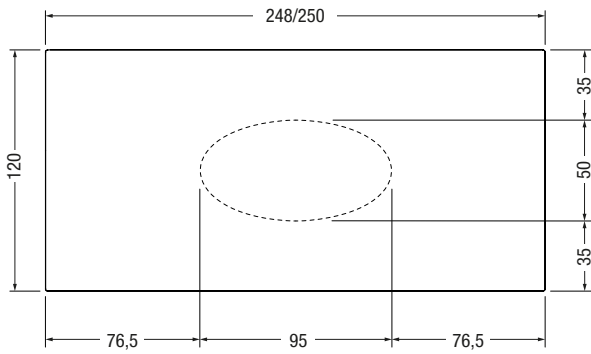

300 x 120

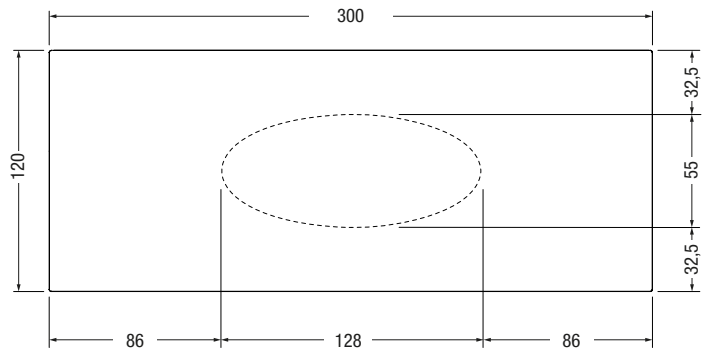

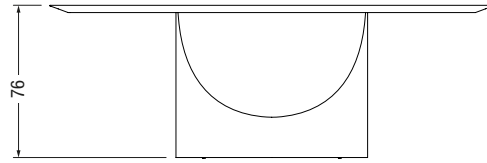

200 x 120

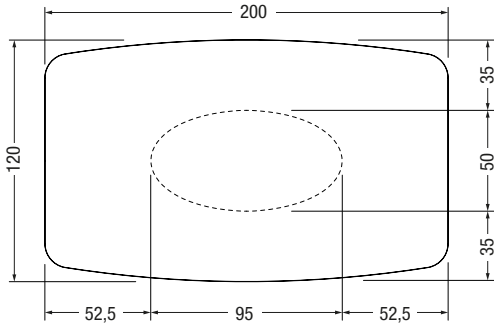

220 x 120

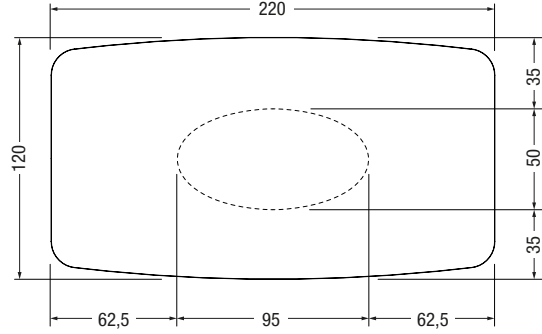

250 x 120

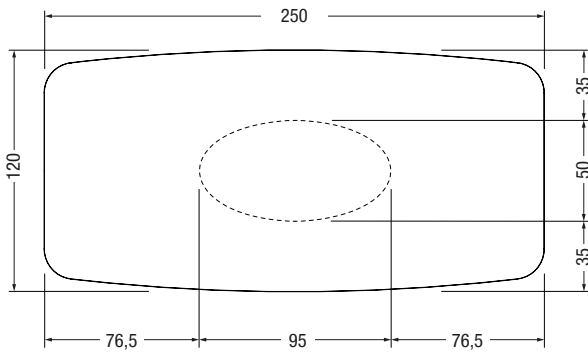

300 x 120

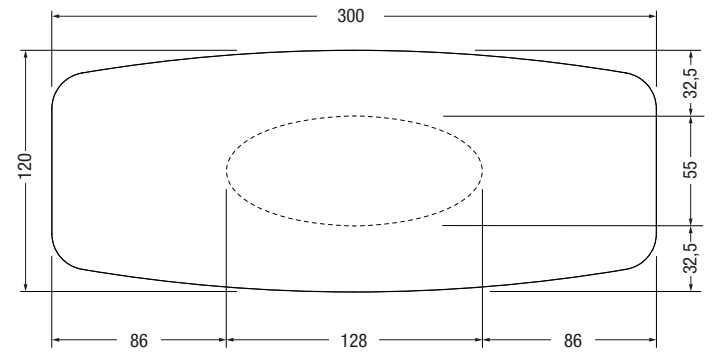

200 x 130

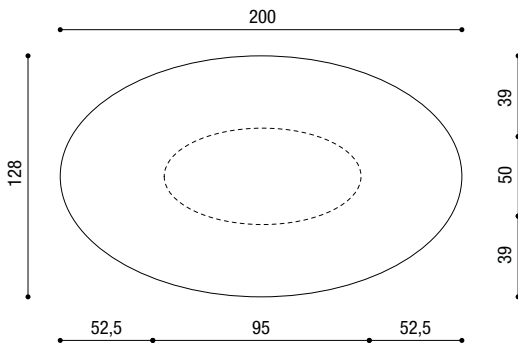

220 x 130

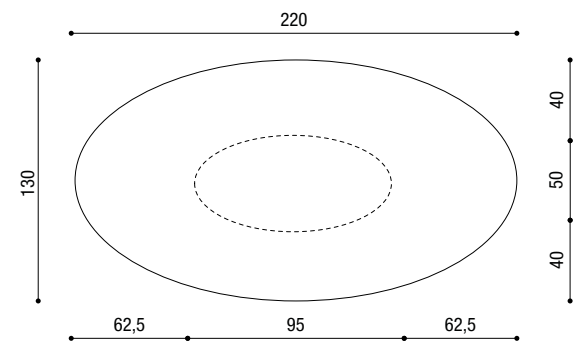

248 x 130

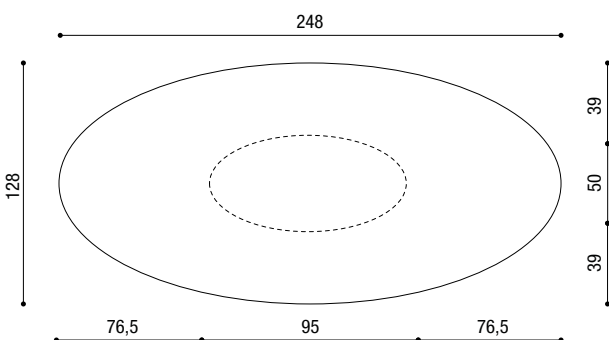

300 x 130

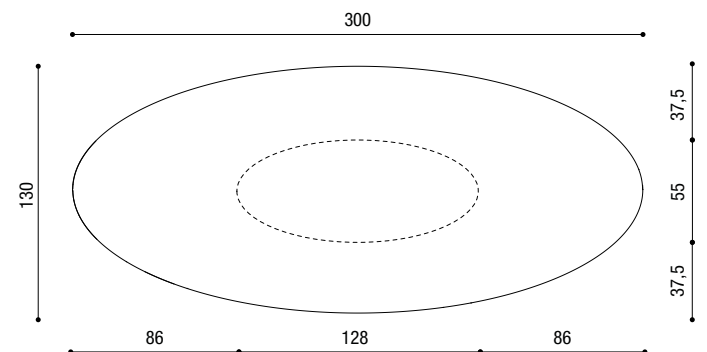

Vetro lucido

EN Polished glass / ES Cristal brillante / FR Verre brillant / DE Glas poliert

Il vetro LAGO cattura lo sguardo con una nuova esperienza del colore, reso vivo, profondo e mutevole al variare delle condizioni della luce. Rigorosamente perfetto, mantiene inalterata attraverso il tempo la propria bellezza. Il vetro ha doti intrinseche di igienicità, facile da pulire in quanto non assorbe lo sporco e le macchie e temperato, ovvero trattato termicamente per ottenere una elevata resistenza all'urto, al graffio e al calore. Viene verniciato all'acqua ed è un materiale riciclabile al 100%.

LAGO glass captures the eye with a new experience of colour, made brilliant, deep and changeable according to light conditions. Rigorously perfect, it preserves its beauty unaltered over time. LAGO glass has intrinsic hygienic properties, it is easy to clean since it does not absorb dirt or stains and it is tempered, that is to say temperature-treated in order to obtain higher resistance to shocks, scratches and heat. It is painted with water-based colour and is a 100% recyclable material.

El vidrio LAGO cautiva la mirada con una nueva forma de vivir el color, vuelto vivo, profundo y cambiante al variar las condiciones de luz. Rigurosamente perfecto, mantiene inalterada en el tiempo su belleza. El vidrio tiene características intrínsecas que lo hacen un material limpio: es fácil de lavar ya que no absorbe la suciedad ni las manchas, y con el templado es tratado térmicamente para obtener una alta resistencia a los golpes, las ralladuras y el calor. Está barnizado al agua y es un material 100% reciclable.

Le verre LAGO accroche le regard avec une nouvelle expérience de la couleur, rendue vive, profonde et changeante en fonction des variations lumineuses. Rigoureusement parfait, il conserve une beauté inaltérée à travers le temps. Le verre a des qualités hygiéniques intrinsèques: il est facile à nettoyer, car il n'absorbe ni la saleté ni les taches, et est trempé, c'est-à-dire traité thermiquement pour renforcer sa résistance aux chocs, aux rayures et à la chaleur. Verni à l'eau, ce matériau est 100 % recyclable.

Das LAGO-Glas lenkt den Blick mit einem neuen Farberlebnis auf sich, das sich Stunde um Stunde mit den Verhältnissen des Lichts als lebendig, tiefgründig und veränderbar erweist. Auf perfekte Art und Weise behält es strengstens seine Schönheit, die sich im Laufe der Zeit kein bisschen verändert. Das Glas verfügt über die einmalige Gabe der Reinheit. Es ist leicht zu reinigen, da es keinen Schmutz und keine Flecken aufnimmt; es ist für eine höhere Resistenz Stößen, Kratzern und Hitze gegenüber temperiert bzw. wärmebehandelt. Es wird mit Farben auf Wasserbasis gestrichen und ist ein 100%ig recyclefähiges Material.



La rappresentazione dei colori ha valore indicativo / The colour representation is indicative / La representación de los colores tiene valor indicativo / La représentation des couleurs est indicative / Die abgebildeten Farben können vom Original abweichen.

Vetro opaco

EN Matt glass / ES Cristal mate / FR Verre mat / DE Glas satiniert

Grazie a un processo di acidatura delle lastre, il vetro opaco LAGO crea nuovi linguaggi compositivi mescolando la perfezione tattile e formale di questo materiale con un effetto visivo sorprendente. Più delicato del vetro lucido ha doti di igienicità ed è temperato, ovvero trattato termicamente per ottenere una elevata resistenza all'urto, al graffio e al calore. Il vetro viene verniciato all'acqua ed è un materiale riciclabile al 100%.

Thanks to an acidizing process, LAGO opaque glass creates new compositional languages, mixing the tactile and formal perfection of this material with a surprising visual effect. More delicate than shiny glass, it has hygienic properties and is tempered, that is to say temperature-treated in order to obtain higher resistance to shocks, scratches and heat. LAGO opaque glass is painted with water-based colour and is a 100% recyclable material.

Gracias a un proceso de acidificación de las láminas, el vidrio opaco LAGO crea nuevos lenguajes compositivos mezclando la perfección táctil y formal de este material con un efecto visual sorprendente. Más delicado que el vidrio brillante, tiene cualidades higiénicas y está templado, es decir tratado térmicamente para obtener una alta resistencia a los golpes, las ralladuras y el calor. El vidrio está barnizado al agua y es un material 100% reciclable.

Grâce à un procédé de traitement à l'acide des plaques, le verre opaque LAGO crée de nouveaux langages de composition, en mêlant la perfection tactile et formelle de ce matériau avec un effet visuel saisissant. Plus délicat que le verre poli, il est hygiénique et trempé, c'est-à-dire traité thermiquement pour une meilleure résistance au chocs, aux rayures et à la chaleur. Ce verre verni à l'eau est un matériau 100 % recyclable.

Dank einer Säurebehandlung der Scheiben, erfindet das Mattglas von LAGO eine neue Kompositionssprache, indem es die tastbare und formale Perfektion dieses Materials mit einem offensichtlichen, erstaunlichen Effekt vereint. Es ist delikater als transparentes Glas und verfügt über hygienische Eigenschaften; ist für eine höhere Resistenz Stößen, Kratzern und Hitze gegenüber temperiert bzw. wärmebehandelt. Es wird mit Farben auf Wasserbasis gestrichen und ist ein 100%ig recyclefähiges Material.



La rappresentazione dei colori ha valore indicativo / The colour representation is indicative / La representación de los colores tiene valor indicativo / La représentation des couleurs est indicative / Die abgebildeten Farben können vom Original abweichen.

Vetro Metal lucido e opaco

^{EN} Polished and matt Metal Glass / ^{ES} Cristal Metal brillante es mate / ^{FR} Verre Métal brillant et mat / ^{DE} Glas Metal poliert und satiniert

Tre colorazioni dai riflessi metallici caldi e cangianti avvolgono le superfici in modo uniforme, donando dinamismo e luminosità al prodotto nelle diverse finiture, lucida e opaca. Colori vivi che producono eleganti effetti visivi al variare della luce naturale e domestica. Realizzati con prodotti all'acqua privi di solventi, garantiscono igienicità e resistenza nel tempo grazie alle proprietà intrinseche del vetro.

Three shimmering metallic colours dominate the surface evenly, creating a bright, warm and dynamic look, available in a range of matt and polished finishes. Vivid colours create elegant visuals as the light changes both indoors and outdoors. Produced using solvent-free, water-based products, your furniture is hygienic and durable over time, thanks to the intrinsic qualities of glass.

Tres coloraciones de reflejos metálicos cálidos y cambiantes envuelven las superficies de manera uniforme, dando dinamismo y luminosidad al producto en los diferentes acabados brillo y mate. Colores vivos que producen elegantes efectos visuales al variar la luz natural y doméstica. Realizados con productos al agua sin disolventes, garantizan higiene y resistencia a lo largo del tiempo gracias a las propiedades intrínsecas del cristal.

Trois coloris aux reflets métalliques chauds et chatoyants enveloppent les surfaces de manière uniforme, tout en donnant dynamisme et luminosité au produit dans les différentes finitions, brillantes et mates. Des couleurs vives qui produisent d'élégants effets visuels selon la variation de la lumière naturelle et domestique. Réalisés avec des produits à l'eau sans solvants, ils garantissent hygiène et résistance dans le temps grâce aux propriétés intrinsèques du verre.

Drei Farben mit warmen, changierenden Metall-Reflexen umhüllen die Oberflächen gleichmäßig und verleihen dem Produkt in den verschiedenen Ausführungen – glänzend und matt – Dynamik und Helligkeit. Lebendige Farben, die bei wechselndem natürlichem und häuslichem Licht elegante visuelle Effekte erzeugen. Sie werden mit lösungsmittelfreien Produkten auf Wasserbasis hergestellt und garantieren dank der charakteristischen Eigenschaften von Glas Hygiene und Haltbarkeit.

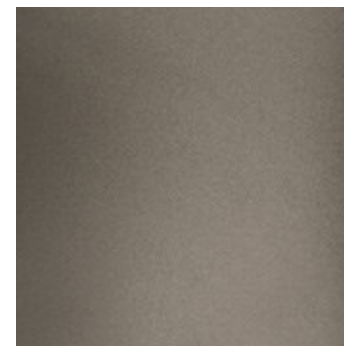

CHAMPAGNE METAL

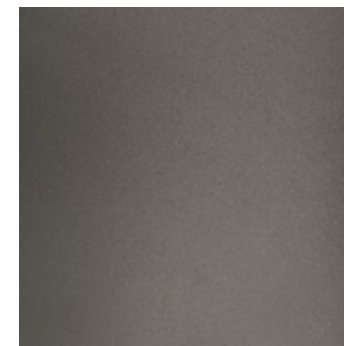

PIOMBO METAL

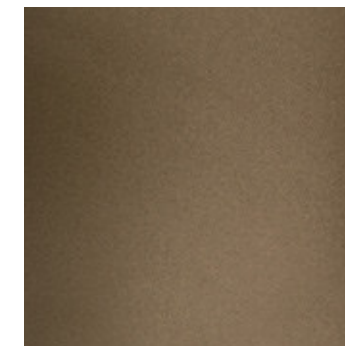

TUNDRA METAL

XGlass lucido e opaco

EN Polished and matt XGlass / ES XGlass brillante es mate / FR XGlass brillant et mat / DE XGlass poliert und satiniert

La rivoluzione tecnologica sta accelerando i processi di innovazione anche nel campo dei materiali, offrendo opportunità incredibili. Grazie alla digital print XGlass coniuga le qualità di un materiale nobile e prezioso come il vetro alle emozioni di molteplici materiali. Le diverse finiture, lucida e opaca, aumentano poi l'empatia con il materiale stesso. Una raffinata continuità di pattern connota le superfici dei prodotti. XGlass è una strategia innovativa anche per poter ridurre in più casi l'impatto ambientale e migliorare quello sociale.

The technological revolution is speeding up innovation and offering incredible opportunities, including in the field of materials. Using digital printing technology, XGlass combines the fine qualities of glass with the emotion of a whole range of other materials. The different finishes, available in glossy and mat, increase empathy with the material itself and a refined continuous pattern defines the surface of each piece. XGlass is also an innovative solution for reducing environmental impact in many cases and improving the social one.

La révolution technologique accélère les processus d'innovation même dans le domaine des matériaux et ouvre la voie à d'incroyables opportunités. Grâce à l'impression numérique, XGlass combine les qualités d'un matériau noble et précieux comme le verre aux émotions de plusieurs matériaux. Les diverses finitions, brillante et opaque, intensifient l'empathie avec le matériau lui-même. Cette continuité raffinée de motifs caractérise les surfaces des produits. XGlass est également une stratégie innovante qui permet de réduire, dans de nombreux cas, l'incidence environnementale et d'améliorer l'impact social.

La revolución tecnológica está acelerando los procesos de innovación en el campo de los materiales, ofreciendo oportunidades increíbles. Gracias a la impresión digital, XGlass conjuga las cualidades de un material noble y preciado como el cristal con las emociones de múltiples materiales. Los diferentes acabados, brillo y mate, aumentan también la empatía con el material mismo. Una elegante continuidad de estampados distinguen las superficies de los productos. XGlass es una estrategia innovadora también para poder reducir en más casos el impacto ambiental y mejorar el social.

Die technologische Revolution beschleunigt Innovationsprozesse auch im Bereich der Materialien und bietet unglaubliche Möglichkeiten. Dank des Digitaldrucks verbindet XGlass die Eigenschaften eines edlen und kostbaren Materials wie Glas mit den Emotionen vieler Materialien. Die verschiedenen Ausführungen, die glänzend und matt erhältlich sind, sorgen für noch mehr Begeisterung. Ein raffinierter Übergang der Muster auf der Oberflächen gibt den Produkte ihren besonderen Charakter. XGlass ist ein innovative Instrument zur Verringerung der Umweltbelastung und zur Verbesserung der sozialen Auswirkungen.

MARBLE XGLASS

Gamma completa - Complete range - Amplia gama - Gamme complète - Umfassende Palette

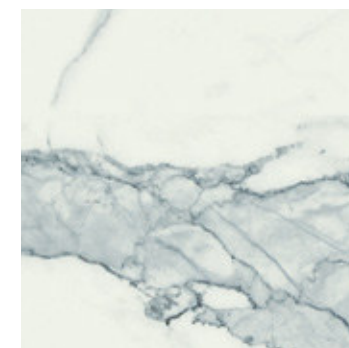

STATUARIO

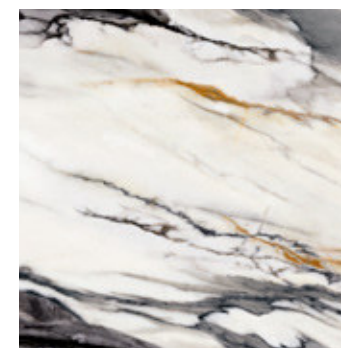

PAONAZZO

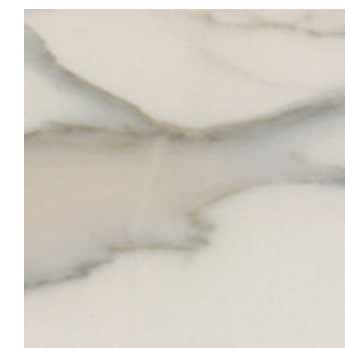

CALACATTA GOLD



ONICE GRIGIO



ONICE

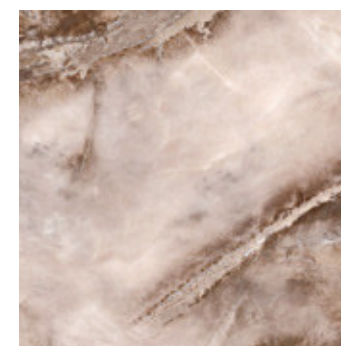

ALABASTRO

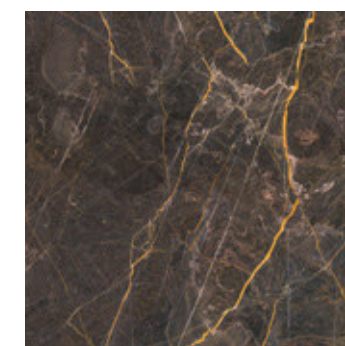

PORT SAINT LAURENT

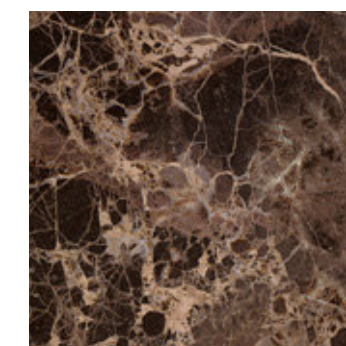

EMPERADOR

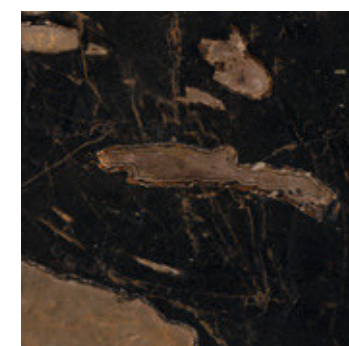

GEODE

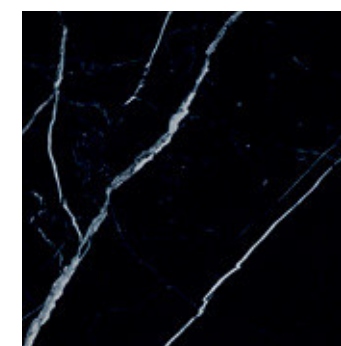

MARQUINA

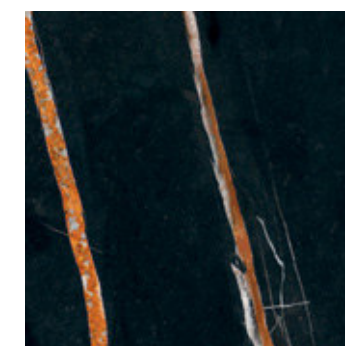

SAHARA NOIR

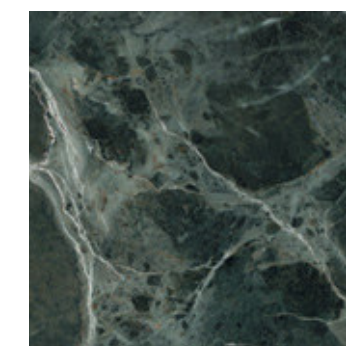

VERDE ALPI

MARBLE XGLASS

Scala 1:3 - Scale 1:3 - Escala 1:3 - Échelle 1:3 - Maßstab 1:3

3 m

2 m

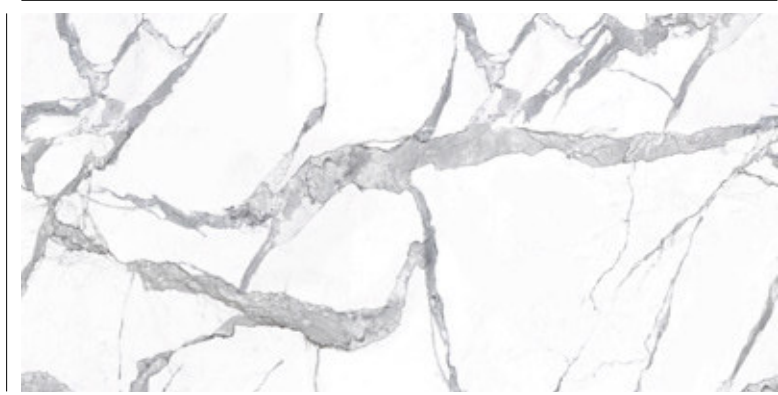

STATUARIO



PAONAZZO

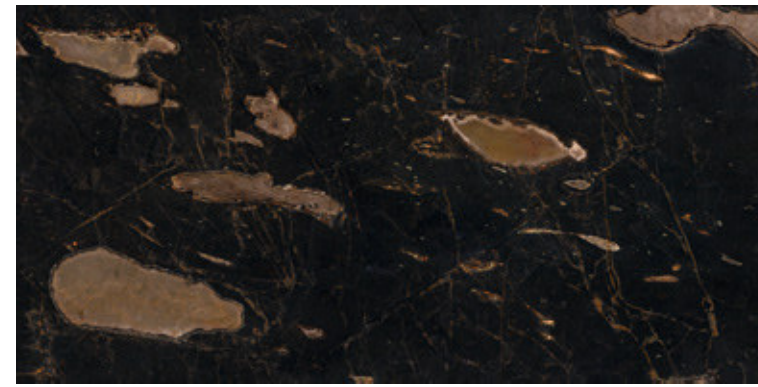

GEODE

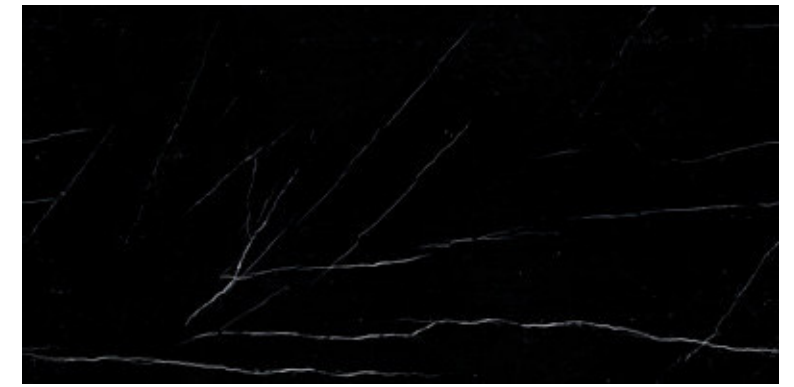

MARQUINA



CALACATTA GOLD

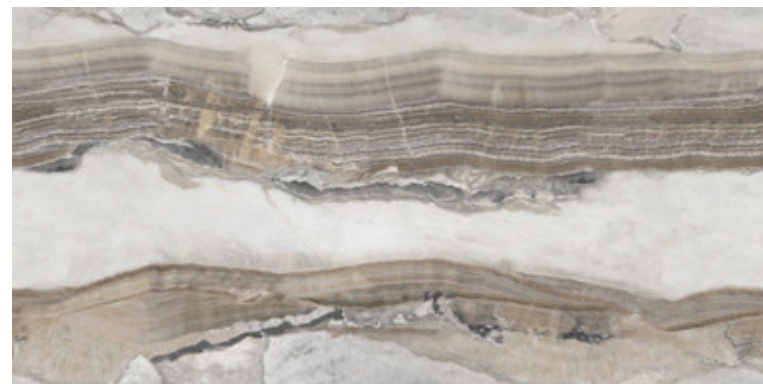

ONICE GRIGIO

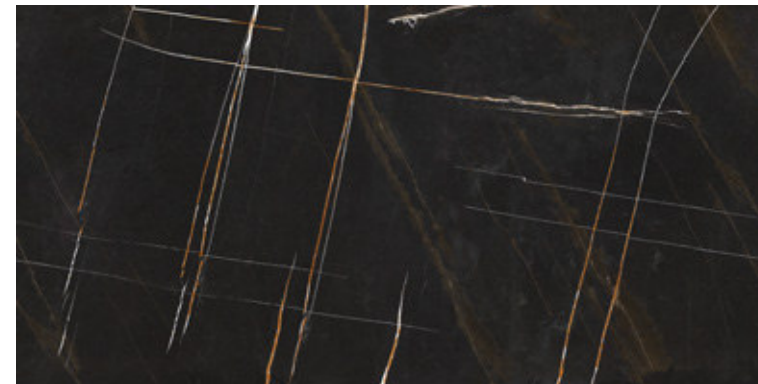

SAHARA NOIR



VERDE ALPI



ONICE



ALABASTRO

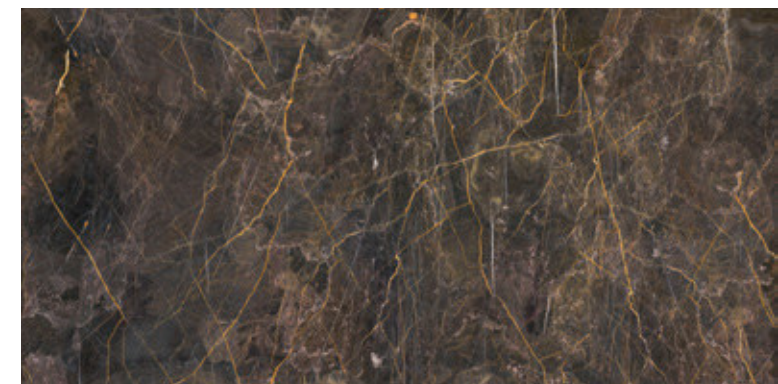

PORT SAINT LAURENT



EMPERADOR

METAL XGLASS



TITANIO



RAME

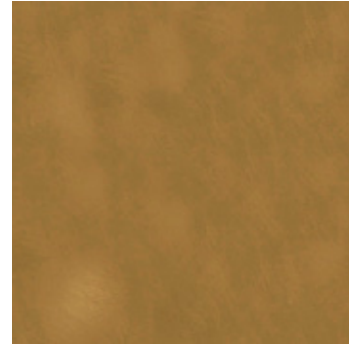

ORO



BRONZO



PELTRO

HOME COUTURE XGLASS

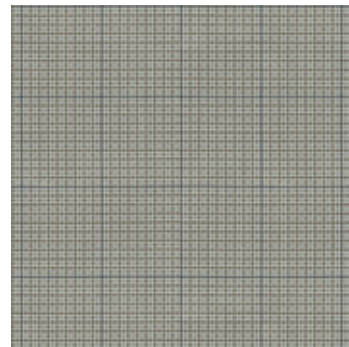

KISS WOOL

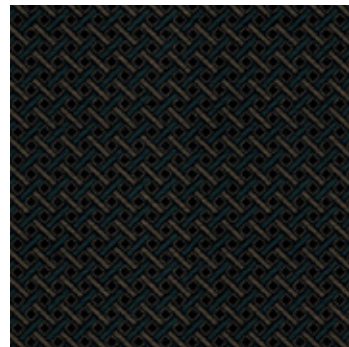

POP PANTS

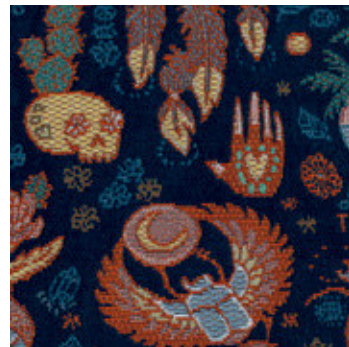

ART & CRAFT

ANIMAL ZERO XGLASS*

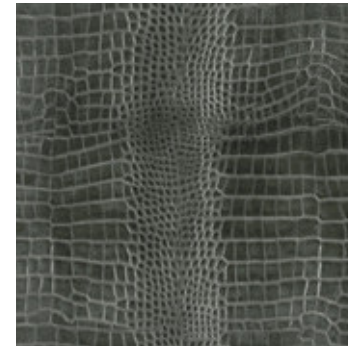

COCCODRILLO VERDE

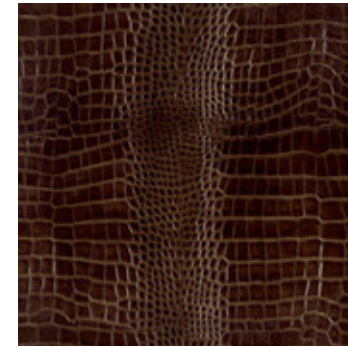

COCCODRILLO MARRONE

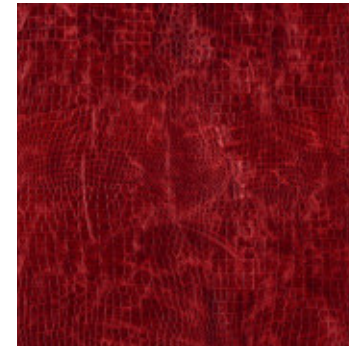

COBRA ROSSO



PITONE

**Disponibile solo nella versione lucida. / Available only in the polished version. / Disponible sólo en la versión brillante. / Disponible uniquement en version brillant. / Nur in der poliert Version erhältlich.*

WOOD XGLASS

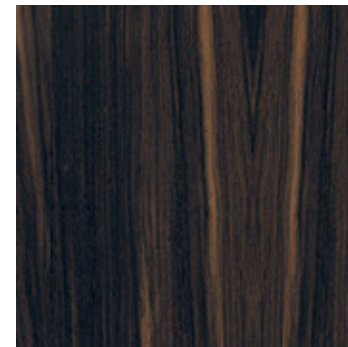

EBANO MACASSAR

Wildwood

Calore, ospitalità, senso del tempo, il legno sa essere primordiale ambasciatore di verità e, allo stesso tempo, di un lusso raffinato e tattile. Realizzato a partire da legno di rovere piallato a mano, il Wildwood è sottoposto a una lavorazione artigianale che ne esalta le naturali imperfezioni. I nodi e le fessure sono stuccati con prodotti speciali ad alta resistenza e una verniciatura protettiva limita la permeabilità della superficie ai liquidi e alle macchie.

Warmth, hospitality, a sense of time: wood is a primordial ambassador of truth and, at the same time, a refined, tactile luxury. Made with hand-planed oak, is artisanally processed to enhance its natural imperfections. The knots and fissures are stuccoed with special highly resistant products and a protective varnish increases the water and stain resistance of the surfaces.

Calor, hospitalidad, sentido del tiempo; la madera sabe ser primordial embajadora de la verdad y, al mismo tiempo, de un lujo refinado y táctil. Realizada a partir de madera de roble cepillada a mano, la madera Wildwood es trabajada artesanalmente resaltando sus imperfecciones naturales. Los nudos y las hendiduras son enmasilladas con productos especiales de alta resistencia y un barnizado protector reduce la permeabilidad de la superficie a los líquidos y las manchas.

Chaleur, hospitalité, sens du temps, le bois sait être le principal ambassadeur de la vérité et, parallèlement, d'un luxe raffiné et tactile. Fabriqué à partir de bois de chêne raboté à la main, Wildwood est un bois travaillé artisanalement: ses imperfections naturelles sont donc exaltées. Les nœuds et les fissures sont stuqués avec des produits spéciaux à haute résistance et la perméabilité de sa surface aux liquides et aux taches est limitée par un vernis protecteur.

Wärme, Gastfreundlichkeit, Zeitgefühl. Holz kann wirklich als der Ur-Botschafter der Wahrheit angesehen und zugleich als ausgearbeiteter und tastbarer Luxus eingesetzt werden. Es entsteht aus Eichenholz, das per Hand gehobelt wird. Das Wildwood wird einer traditionellen Bearbeitung per Hand unterworfen, die die natürliche Unvollkommenheit dieses Holzes rühmt und hervorhebt. Die Baumknoten und -ritzen sind mit speziellen Produkten für eine hohe Festigkeit gekittet. Ein Schutzlack versiegelt die Oberfläche, wodurch diese für Flüssigkeiten und Flecken undurchlässig werden.



CHIARO



NATURALE



TABACCO

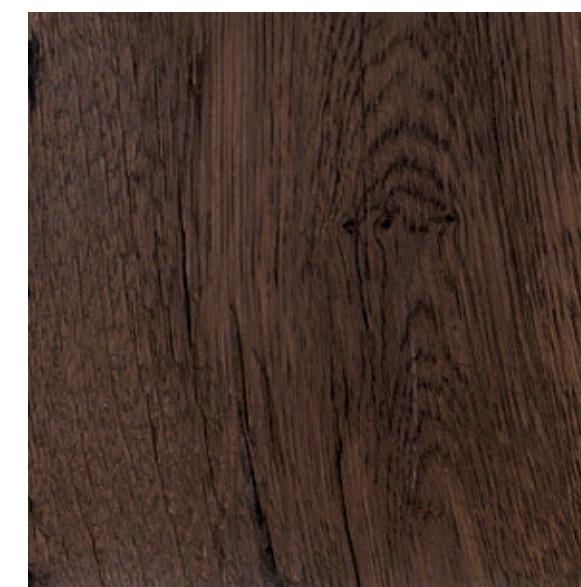

SCURO

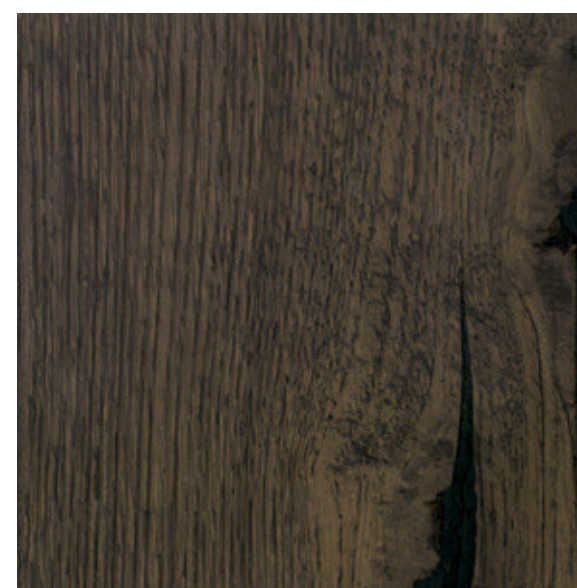

GRIGIO

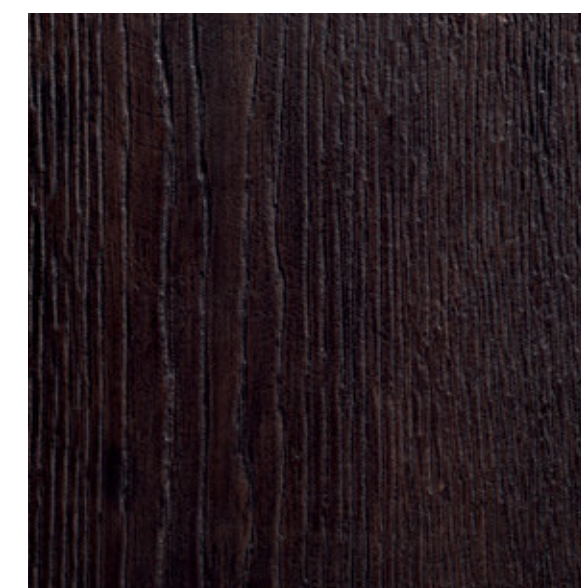

NERO