

SOVET

ITALIA



Totem

collection booklet

collection booklet

Totem

Design **Studio Sovet**

“
A lacquered metal base meets a top in glass, wood, ceramic or *Materia*, to give life to a tables collection with a distinctive personality and versatility in the setting, from home to contract spaces.

Una base in metallo laccato incontra un piano in cristallo, legno, ceramica o *Materia*, per dare forma a una famiglia di tavoli e tavolini tanto ricchi di personalità, quanto versatili nell'ambientazione: dagli ambienti domestici, agli spazi contract.

”

Models & Dimensions

Dining table with lacquered metal base, various finishes. Tempered or laminated top in different measures, materials and finishes.

Tavolo con base in metallo laccato, varie finiture. Top temperato o stratificato in varie misure, materiali e finiture.

round

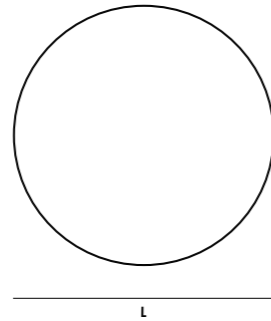
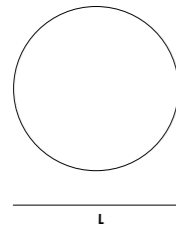
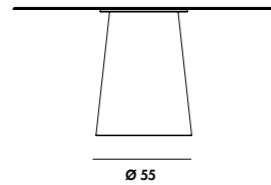
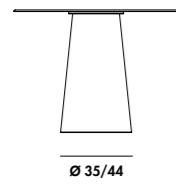

Ø62x75h
Ø80x75h
Ø100x75h
Ø120x75h
Ø130x75h
Ø140x75h
Ø150x75h
Ø170x75h

elliptical

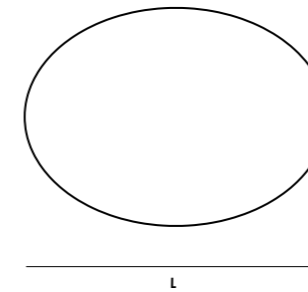
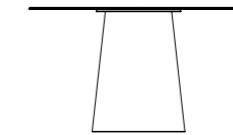
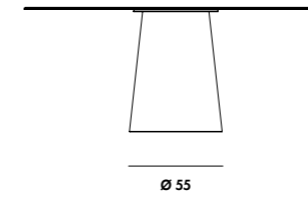

180x130x75h
200x110x75h
220x130x75h

shaped

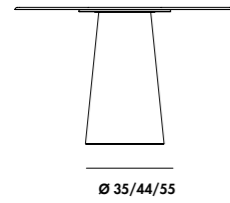

62x62x75h
 80x80x75h
 100x100x75h
 120x120x75h
 130x130x75h
 140x140x75h
 150x150x75h

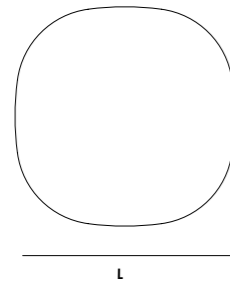

bar



Ø62x75h
 Ø80x75h
 Ø62x110h
 70x70x75h
 70x70x110h

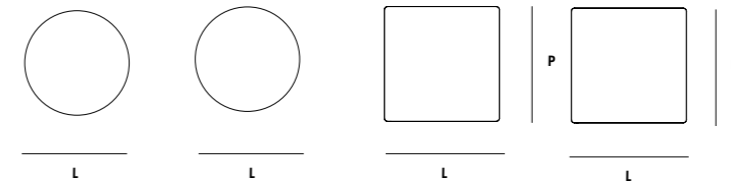

shaped two bases

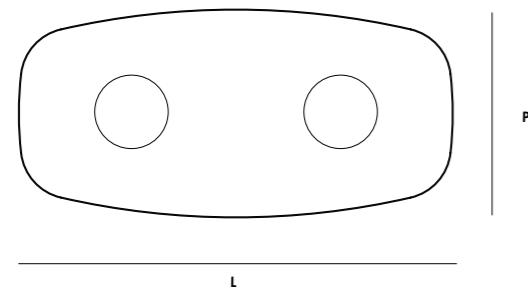
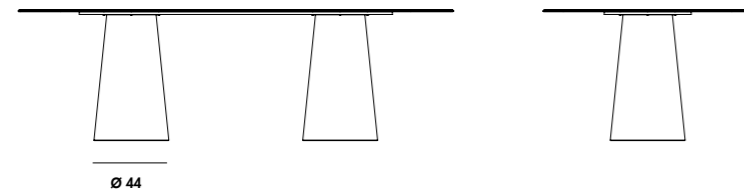

220x115x75h
 250x120x75h
 300x135x75h

extensible

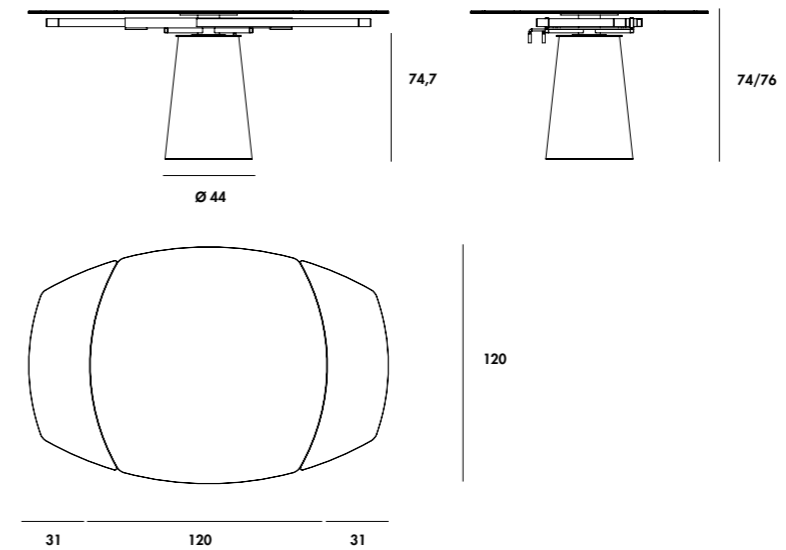

open
 120x120x74/76h

close
 182x120x74/76h

collection
finishes



top

Glass Vetro

CAT. B



TEB1
Extralight glass lacquered
milky white
Vetro extrachiaro laccato
bianco latte



TEC1
Extralight glass lacquered
mocha
Vetro extrachiaro
laccato caffè



TEC2
Extralight glass lacquered
clay
Vetro extrachiaro
laccato creta



TEC3
Extralight glass lacquered
cement
Vetro extrachiaro
laccato col. cemento



TER4
Extralight glass lacquered
rust
Vetro extrachiaro
laccato col. ruggine



TEV2
Extralight glass lacquered
moss green
Vetro extrachiaro
laccato col. muschio



TEN1
Extralight glass lacquered
black
Vetro extrachiaro
laccato nero

CAT. D



TEM6
Vetro extrachiaro
laccato col. tabacco
Extralight glass
laccato tabacco



TES1
Vetro extrachiaro
laccato champagne
Extralight glass lacquered
champagne

Frosted glass Vetro acidato

CAT. E



AEB1
Extralight glass lacquered
mocha
Vetro extrachiaro
laccato caffè



AEC2
Frosted clay glass
Vetro acidato creta



AEC3
Frosted cement glass
Vetro acidato
col. cemento



AES1
Frosted champagne
glass
Vetro acidato
champagne

Net glass

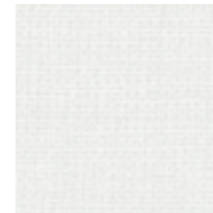

NEB1
White Net glass
Net glass bianco

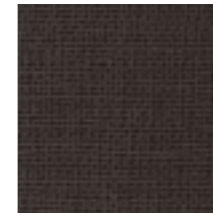

NEC1
Mocha Net glass
Net glass caffè

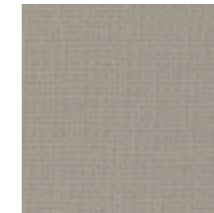

NEC2
Clay Net glass
Net glass creta

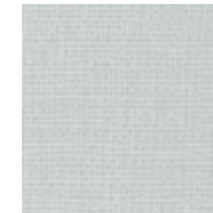

NEC3
Cement Net glass
Net glass col. cemento



NER4
Rust Net glass
Net glass col. ruggine

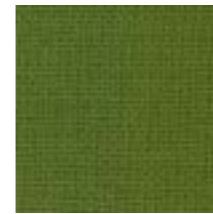

NEV2
Moss green Net glass
Net glass col. muschio

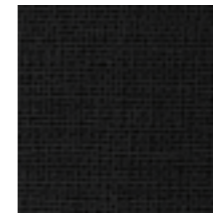

NEN1
Black Net glass
Net glass nero



NEM6
Tobacco
Net glass
Net glass col.
tabacco



NES1
Champagne
Net glass
Net glass
champagne

Liquid glass/materia



LFSP
Smoked Liquid glass
mirrored
Liquid glass fumè
specchiato



LBSP
Bronzed Liquid glass
mirrored
Liquid glass bronzo
specchiato

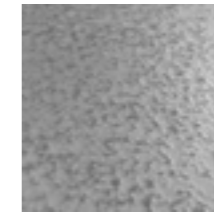

MESP
Extralight mirror
materia
Materia extrachiaro
specchio



MBSP
Extralight bronzed
materia
Materia extrachiaro
bronzo



MES1
Extralight champagne
materia
Materia extrachiaro
champagne

Wood

Legni

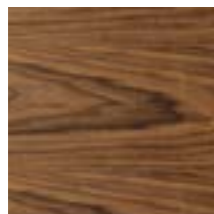

NC

Canaletto walnut
Noce Canaletto



RN

Natural oak wood
Rovere naturale



RG

Grey lacquered oak
Rovere tinto grigio

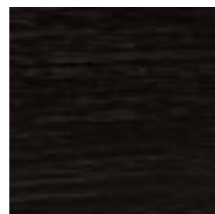

WG

Wengé-stained oak
Rovere tinto wengé

HPL



HB

White black edge
Bianco bordo nero

Ceramic

Ceramica

Categoria CE1

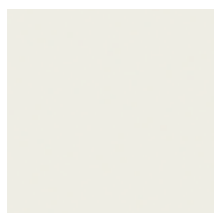

CT

Ceramic titanio
Ceramica titanio



CJ

Ivory black ceramic
Ceramica Ivory Black

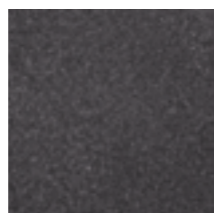

CD

Dark ceramic
Ceramica dark



CG

Grey ceramic
Ceramica grey



CZ

Ceppo di Grè ceramic
Ceramica Ceppo di Grè



CC

Pre-polished Calacatta ceramic
Ceramica Calacatta Prelucidata



CX

Pre-polished Stone Grey ceramic
Ceramica Stone Grey Prelucidata

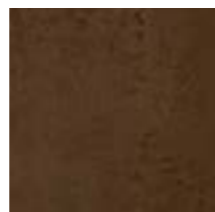

KC

Corten ceramic
Ceramica Corten

Ceramic

Ceramica

Categoria CE2



CA

Arabescato light ceramic
Ceramica Arabescato light

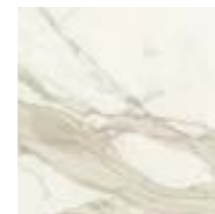

CL

Polished Calacatta ceramic
Ceramica Calacatta lucida



CY

Stone grey ceramic
Ceramica Stone grey



CU

Gaudi Stone ceramic
Ceramica Gaudi Stone

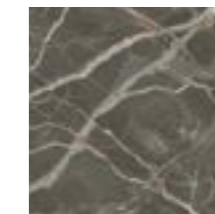

CV

Ombra di Caravaggio ceramic
Ceramica Ombra di Caravaggio



CH

Grey onyx ceramic
Ceramica Onice grigio



CI

Gold Onyx ceramic
Ceramica Onice oro

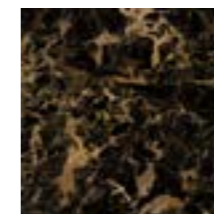

KO

Black Gold ceramic
Ceramica Black Gold



CQ

Polished Marquinia ceramic
Ceramica Marquinia lucida



CF

Eramosa ceramic
Ceramica Eramosa

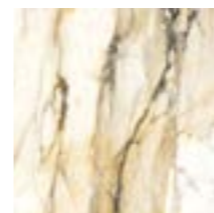

CW

Antique ceramic
Ceramica Antique

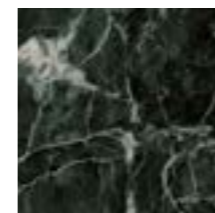

KV

Green Aver ceramic
Ceramica verde Aver

base

Metal

Metallo



GN
Embossed black
Nero goffrato



GB
Embossed white
Bianco goffrato



GC
Embossed Mocha
Caffè goffrato



GT
Embossed clay
Creta goffrato

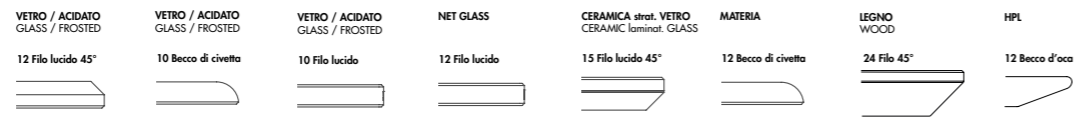

Bordi/Edges

		VETRO / ACIDATO GLASS / FROSTED	VETRO / ACIDATO GLASS / FROSTED	VETRO / ACIDATO GLASS / FROSTED	NET GLASS	CERAMICA strat. VETRO CERAMIC laminat. GLASS	MATERIA	LEGNO WOOD	HPL
round									
14	●	Ø 62x75h	•	•	•	•	•	•	•
	●	Ø 80x75h	•	•	•	•	•	•	•
	●	Ø 100x75h	•	•	•	•	•	•	•
	●	Ø 120x75h	•	•	•	•	•	•	•
	●	Ø 130x75h	•	•	•	•	•	•	•
	●	Ø 140x75h	•	•	•	•	•	•	•
	●	Ø 150x75h	•	•	•	•	•	•	•
	●	Ø 170x75h	•	•	•	•	•	•	•
bar									
●	Ø 62x75h	•	•	•	•	•	•	•	•
●	Ø 80x75h	•	•	•	•	•	•	•	•
●	Ø 62x110h	•	•	•	•	•	•	•	•
■	70x70x75h	•	•	•	•	•	•	•	•
■	70x70x110h	•	•	•	•	•	•	•	•
shaped									
●	62x62x75h	•	•	•	•	•	•	•	•
●	80x80x75h	•	•	•	•	•	•	•	•
●	100x100x75h	•	•	•	•	•	•	•	•
●	120x120x75h	•	•	•	•	•	•	•	•
●	130x130x75h	•	•	•	•	•	•	•	•
●	140x140x75h	•	•	•	•	•	•	•	•
●	150x150x75h	•	•	•	•	•	•	•	•
elliptical									
●	180x130x75h	•	•	•	•	•	•	•	•
●	200x110x75h	•	•	•	•	•	•	•	•
●	220x130x75h	•	•	•	•	•	•	•	•
shaped two bases									
●	220x115x75h	•	•	•	•	•	•	•	•
●	250x120x75h	•	•	•	•	•	•	•	•
●	300x135x75h	•	•	•	•	•	•	•	•

Materiali e manutenzione

ITA

Vetro

Le laccature utilizzate non presentano problemi di durata: basta evitare graffi e urti contro oggetti particolarmente duri e spigolosi. Il vetro è colorato solo sulla faccia posteriore sia nei vetri laccati coprenti mono e bicolore che nei vetri acidati laccati. La tonalità dei campioni proposti è indicativa e non va pertanto intesa in senso restrittivo; può infatti differire leggermente in conformità ai margini di tolleranza riconosciuti per i materiali impiegati. I materiali impiegati possono essere puliti tranquillamente solo con acqua oppure con un detergente neutro. Evitare l'uso di abrasivi, acidi o reagenti chimici. Il vetro è interpretato attraverso la sua trasparenza, pertanto la conformità al campione può differire a seconda della superficie e degli spessori impiegati. Un esempio lampante è dato dal vetro extrachiario che nei campioncini si presenta completamente neutro ma che nei piani di dimensioni maggiori e con spessori più consistenti assume sfumature azzurro/verdi. Per tale ragione vi preghiamo anche di segnalare con particolare attenzione articoli che debbano essere affiancati o facenti parte di una stessa commissione.

La finitura bicolore consiste nella doppia laccatura nella parte interna della lastra di vetro. La prima laccatura, visibile attraverso la trasparenza del vetro, è disponibile nelle categorie B-D. La seconda laccatura, visibile internamente, equivale al colore pastello opaco utilizzato per ottenere le finiture di cat. B. Vi facciamo presente che in questo caso l'effetto finale differisce da quello creato dalla medesima laccatura attraverso il vetro, in particolare nei colori tenui.

Specchi

Gli specchi oro e rosa potrebbero presentare delle piccole imperfezioni dovute alle caratteristiche tecniche del materiale. Non possono essere utilizzati in luoghi umidi. Pulire solo con panni asciutti.

Ceramica

I campioni riportati sono una parte delle lastre che vengono lavorate. La lastra completa si può vedere nella corrispondente cartella. Pulire utilizzando acqua e una piccola quantità di detergente neutro. Evitare l'utilizzo di detersivi contenenti cere e prodotti ceranti per evitare la formazione di strati untuosi.

Legno

I colori dei legni sono campioni indicativi. Pulire utilizzando un panno morbido inumidito.

Metalli

I colori dei metalli sono campioni indicativi. Pulire utilizzando un panno morbido inumidito.

Tessuti/Pelli/Ecopelli/Velluti

I colori dei tessuti sono campioni indicativi. Per la cura e la manutenzione fare riferimento alle indicazioni riportate nelle rispettive cartelle e alle schede tecniche fornite dai produttori.

Se permangono dubbi contattare l'azienda.

Colours and maintenance

ENG

Glass

The lacquering used for our furniture is extremely durable as long as you avoid scratching it or bumping particularly hard/sharp objects against it. The glass is lacquered only on the back side both for mono or two-tones lacquered and frosted lacquered glasses. The shade of the samples is only indicative and has not to be taken as restrictive. It can in fact slightly differ in conformity to the tolerances recognized for the materials used. All the materials we use can be easily cleaned with water only or with a mild detergent. Do not use abrasive materials, acids or harsh chemicals. The glass is interpreted through its transparency, therefore the conformity to the sample might differ according to the surface and the thickness used. For example, the extralight glass is completely neutral when seen in the small samples, but it takes a light blue/greenish shade when used on bigger or thicker tops. For this reason, we beg you to indicate carefully those articles which have to be placed side by side or which are part of the same commission.

The two-tones finish consists of a double lacquering on the internal part of the glass sheet. The first lacquering, which is visible through the transparency of the glass, is available in the finishes of cat. B-D. The second lacquering, which is visible internally, is the same of the mat pastel used to get the finishes of cat. B. Please notice that the final effect is different from the one created by the same lacquering through the glass, in particular when it comes to soft colours.

Mirrors

Gold and rose mirrors could have small imperfections due to the particular technical characteristics of the material. We recommend not to use them in damp areas. Clean only with a dry cloth.

Ceramic

The shown samples are part of the bigger slabs Sovet works with. The complete slab is visible in the corresponding folder. Clean using water and a small amount of neutral detergent. Avoid using detergents with wax and waxing products to avoid the formation of greasy layers.

Wood

Wood colours are indicative samples. Clean using a damp soft cloth.

Metals

Metals colours are indicative samples. Clean using a damp soft cloth.

Fabrics/Leathers/Fake leathers/velvets

Fabrics colours are indicative samples. For care and maintenance please refer to the instructions present in the corresponding folders and to the technical sheets provided by the manufacturers.

In case of further doubt please get in touch with the factory.



Totem round base GC top CV.
Autumn chairs base DF seat P53 leather.



Totem round top RG.



Totem round base GC top RG.
Pura chairs upholstered in Kvadrat Hallingdal 153.





Totem round base GN top RG.
Cadira S wire chair base GN seat in Trevira Z09.





Totem shaped two bases base GN top CQ.
Sila chairs base GN seat velvet Z09.
Traled lamp ceramic CQ.



Totem elliptical base GT top TEV2.

In the next page **Totem** elliptical base GT top TEV2.

Pura chair upholstered in Kvadrat Hallingdal 103.







Totem bar round and square base GT top HB.
Sila chairs base GT seat in RN.
Bell lamp.



designer

Studio Sovet

Studio Sovet is the development and design department of SO.VE.T. The team is composed of a group of figures that collaborate to create unique projects. For SOVETITALIA the good design raises in fact from the dialogue of ideas and concepts between people. The richness of this exchange leads to create unique products that resonate with their inner meanings of wisdom, craftsmanship and technology. These are the strengths of a company that has quality, design and service as a primary mission.

Studio Sovet è il dipartimento di sviluppo e progettazione di SO.VE.T. Il team è composto da un insieme di figure che collaborano tra di loro per creare progetti unici. Per SOVETITALIA il buon design, infatti, nasce dal dialogo di idee e concetti tra le persone. La ricchezza di questo scambio porta a creare dei prodotti unici che richiamano al loro interno i significati di sapienza, artigianalità e tecnologia. Questi sono i punti di forza di un'azienda che fa della qualità, del design e del servizio al cliente una mission.

SOVET
ITALIA

sustainability is made up of facts.

Sovet has always maintained a high attention to eco-compatibility since its birth in 1987, through the selection of raw materials and the study of production processes that have the lowest impact on the environment with the aim of creating long-lasting products.

Sovet ha sempre mantenuto alta l'attenzione all'ecocompatibilità sin dalla sua nascita nel 1987, attraverso la selezione delle materie prime e lo studio di processi produttivi che abbiano il minimo impatto sull'ambiente con lo scopo di creare prodotti durevoli nel tempo.

photovoltaic systems

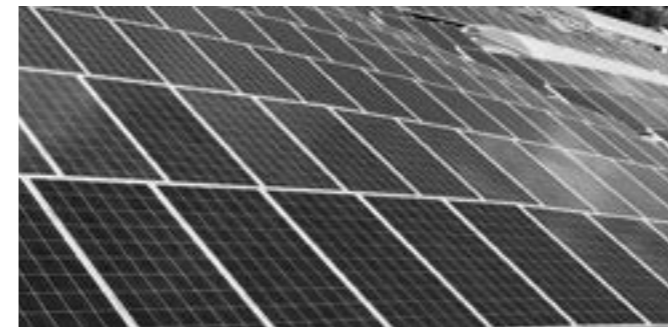

For its production processes, Sovet uses energy coming directly from renewable sources. Thanks to its photovoltaic systems, it is able to meet its own energy demand.

Per la sua produzione Sovet utilizza infatti energia derivante direttamente da fonti rinnovabili. Attraverso impianti fotovoltaici riesce a soddisfare il proprio fabbisogno energetico.



502695,549 kg emissions saved per year



2989 trees saved per year



165 barrels of oil saved per year

packaging



Sovet uses cardboard packaging with limited presence of oil-derivates.

Sovet usa imballi di cartone costruiti ad hoc con limitata presenza di derivati del petroli.



reducing plastic is an habits



To reduce the consumption of plastic and disposable bottles within its offices and production, Sovet created metal water bottles.

Per ridurre il consumo di plastica e bottiglie monouso all'interno dei suoi uffici e della produzione, Sovet ha creato delle borracce in metallo.

made in italy

The creative use of industrial processes, the use of raw materials of highest quality and the scrupulous work of master craftsmen, allow Sovet to create high quality and 100% Made in Italy collections. Thanks to state-of-the-art industrial automation systems, Sovet is also able to meet also large supply needs for contract spaces, always granting the highest quality standards. The company takes a continuous search path for materials, to create an offer of accessories that complement one another, furnishing different kinds of environments with the maximum freedom when it comes to customization.

L'impiego creativo dei processi industriali, l'utilizzo di materie prime di assoluta qualità e le scrupolose lavorazioni eseguite da maestranze artigiane, permettono a Sovet di ottenere collezioni di alta qualità e 100% Made in Italy. Grazie a sistemi di automazione industriale all'avanguardia Sovet è in grado di soddisfare anche esigenze per grandi forniture destinate a spazi contract, sempre garantendo i più elevati standard qualitativi. Sovet intraprende un percorso di ricerca dei materiali per creare un'offerta di complementi che si integrino tra di loro, arredando varie tipologie di ambienti con la massima possibilità di personalizzazione.





[sovet.com](https://www.sovet.com)