



PENDANT LIGHTING

BY

Renzo Serafini

RENZO SERAFINI



LIVINGSPACE
& PARTNERS

Un filo mi ha condotto fino a qui.

Amo definire la mia Luce semplice, polverosa, imperfetta, ma allo stesso tempo credo sia quasi impossibile darle una definizione precisa.

La luce è un'idea, un concetto, una filosofia di intendere il mondo che ci circonda, una lente attraverso cui guardarlo. L'esperienza di uno spazio è influenzata dalla luce e il modo in cui viviamo un ambiente dipende anche dalla giusta illuminazione.

La uso come materiale di progettazione e come strumento per raccontare, emozionare, innescare suggestioni.

Posizionando una lampada in uno spazio, quello spazio si trasforma, si anima, vive, e la visione che abbiamo cambia, indipendentemente dal design del prodotto.

***Siamo falene,
cerchiamo la luce.***

È sostanza immateriale
che modella e scolpisce,
rivela forme e storie.

Architettura morbida e madre genitrice.

Dal greco φαος (phaos/phōs) ha come radice
"mostrare, rendere manifesto".

Luce faro e luce guida.

E con tutti i chiaroscuri di questo mondo così complesso,
la mia Luce è il Filo di Arianna
che conduce verso l'uscita del labirinto.
Le creo il percorso, la uso, la faccio amare.
Lei che rivela e svela,
e che a volte acceca.

A bright luminous line is what led me here.

I love to define my light as simple, dusty, imperfect, but at the same time I think it is also near impossible to give it an exact definition.

Light is an idea, a concept and a philosophy of understanding the world around us. It is a lens to look through. How we experience a space is influenced by light and the way we live in a given environment also depends on the right lighting.

I use it as design material and as a tool to tell,
excite and evoke suggestions.

By placing a lamp in a space, that same space is transformed, animated and becomes alive. The vision that we have changes, regardless of the design of the product.

***We are like moths,
we are in search of light.***

It is an immaterial substance that shapes and sculpts.
Light reveals forms and stories.

Soft architecture and an inception.

From the Greek φαος (phaos/phōs) in effect
"to show, to manifest".

A light house and a guiding light.

And with all the light and darkness that exists in this complex world, my light is like Ariadne's thread that leads towards the exit of the labyrinth. I create a path for her, she uses it and I make her love it. It reveals and unveils but at times is blinding.

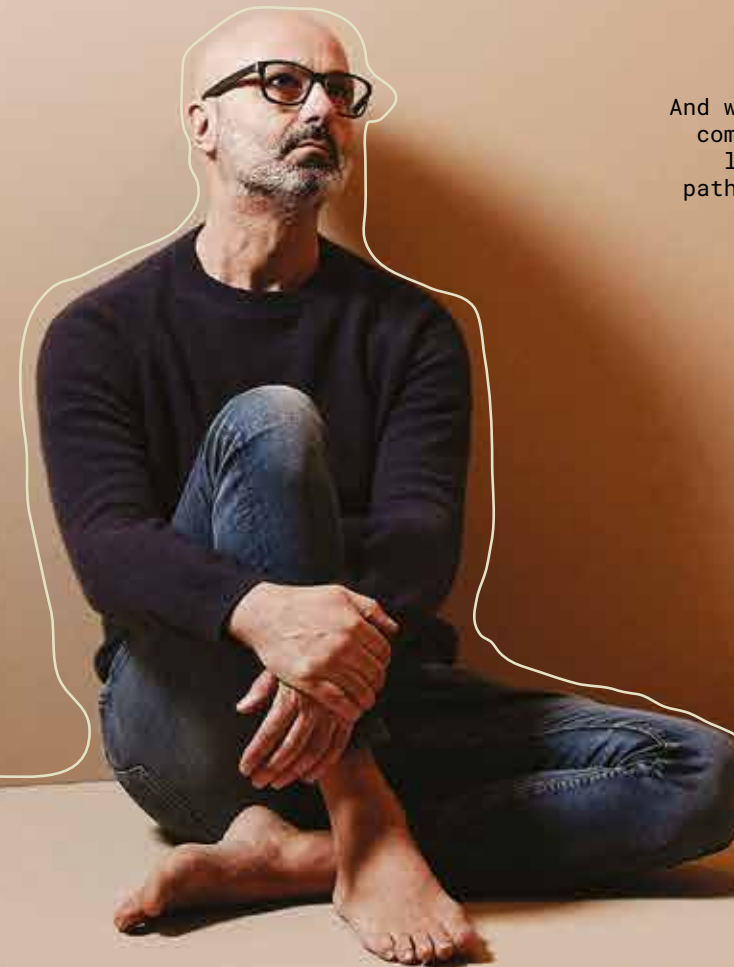

Fatto a mano per noi significa poter creare un prodotto in varie forme e misure, pensato, progettato e realizzato come risposta a delle specifiche esigenze. Una luce sartoriale creata su misura.

Fatto a mano per noi significa trasferire su quel prodotto la sapienza, la conoscenza e l'abilità che solo delle mani esperte possono avere. Vuol dire dare alla luce un prodotto unico in un mondo fatto in serie. Ogni lampada è creata da persone che sanno quello che fanno e che amano farlo.

Dal disegno iniziale alla realizzazione finale, costruiamo ciò che progettiamo e lo facciamo con mani curiose, appassionate e vive.

Fatto a mano significa anche imperfetto.

E così capita che un tubolare di ferro al momento del taglio non rimanga intatto, che durante la lavorazione di un materiale nascano sottili linee, piccole smagliature, insolite e personali, o ancora che delle texture non siano perfettamente uniformi ma che presentino cicatrici, rughe, percorsi e di nuovo indizi da seguire che conducono alla storia del prodotto e a quella dell'artigiano che l'ha realizzato. Una sorta di impronta umana. *Io son passato di qui*, per riprendere di nuovo quel filo che collega l'artigiano, il prodotto, voi.

Imperfetto vuol dire unico, autentico, irripetibile.

Handmade by our definition means being able to create a product in various shapes and sizes: imagined, designed and manufactured as a proposal to precise and specific needs. It is a light that is custom made.

Handmade for us also means transferring to that product all the wisdom, knowledge and skill that only expert hands can possess. It means we offer a unique product in a world where everything is mass-produced. Each lamp is created by people who know what they are doing and who love doing it.

From the initial design to completion, we build what we design and we do it with curious, passionate and lively hands.

Handmade also means imperfect. It can happen that a tube of iron does not remain intact at the time of cutting and that during the processing of materials, thin lines, and small unusual unique marks do arise. There are even textures that are not perfectly uniform. In a sense, they present scars, wrinkles, paths and clues as to what is the story of the product and of the craftsman who made it. It is a sort of human imprint, I have come this way -to take up once again that thread that connects the craftsman, the product, you.

Imperfect means unique, authentic, unrepeatabile.

Luce oltre.

Impariamo dalla luce ad adattarci a spazi e cambiamenti. Come una carovana ci spostiamo avanti e indietro nel tempo, per unire all'intelligenza di oggi la lungimiranza di ieri, in una migrazione collettiva verso la sostenibilità. Valutiamo l'impatto delle nostre azioni, anche quando sono piccole come lampadine.

Una luce che continua a risplendere nel tempo.

I corpi luminosi inseriti all'interno dei prodotti che realizziamo, sono Moduli LED Sostituibili che lasciano la libertà di essere cambiati, come si faceva un tempo, riducendo così gli sprechi e garantendo lunga vita al prodotto. Rendere le varie parti singolarmente sostituibili in caso di usura o rottura, facilita la sostituzione del pezzo con un vantaggio a livello economico e ambientale.

Moduli LED con colori intensi e sfumature di bianco con la stessa precisione della luce naturale, basso impatto ambientale e un'elevatissima qualità luminosa, sempre dimmerabili, per garantire l'intensità di luce adatta ad ogni situazione e ambiente.

E se l'economia lineare di cui si ciba il mondo si basa su produzione-consumo-smaltimento, ecco che noi ci aggiungiamo riparabilità-durevolezza-riciclo e di nuovo con un filo andiamo a unire le estremità, fino a creare un cerchio.

Questo è la strada che seguiamo, questa è l'essenza del design di qualità: costruire bene per durare nel tempo.

Beyond the Light.

We learn from light to adapt to spaces and changes, like a vehicle we move back and forth in time to combine today's intelligence with yesterday's foresight, This is a collective direction towards sustainability. We must evaluate the impact of our actions, even when they are as small as light bulbs.

A light should continue to shine over time.

The light fixtures inserted inside the products we make are Replaceable LED Modules that leave the freedom to be changed as they were done in the past, thus reducing waste and ensuring a long life of the product. Making the various parts individually replaceable in the event of wear or breakage facilitates the replacement of the part with an cost effective and environmental benefit.

These **LED modules** with intense colors and shades of white have the same precision as natural light as well as a low environmental impact and a very high light quality. They are always dimmable to ensure the right light intensity for every situation and environment.

And if the linear economy that this world feeds on is based on production, consumption and disposal, then we have now added repairability, durability and recycling. Once again with a line of thread we can join the ends until we create a circle.

This is the path we follow, this is the essence of quality design: built well in order to last the time.

SOSPESE

PENDANDT

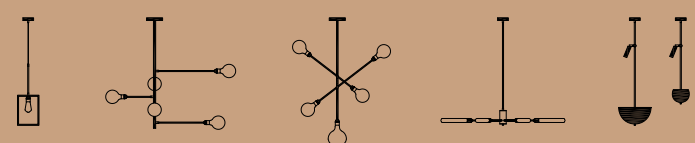
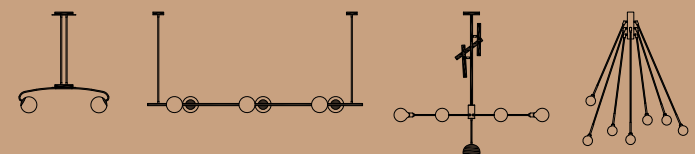
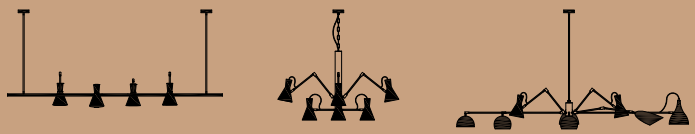
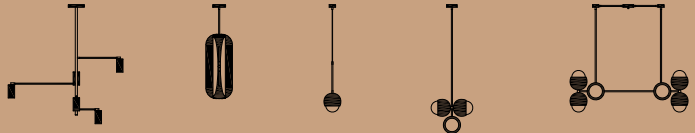
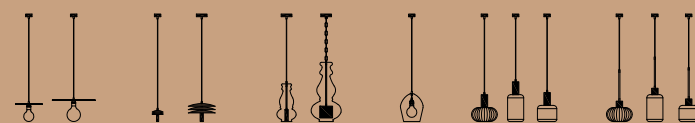
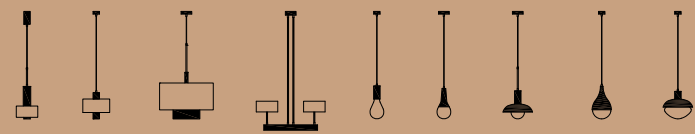
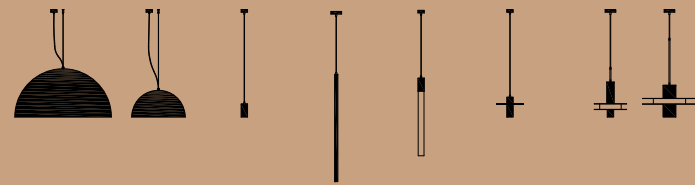

CERCHIO CON SPOT

10.059

Corpo e rosone in acciaio, cilindri piccoli in alluminio, cavo di alimentazione tessuto nero, sostegni in acciaio 2 mt, driver integrato in struttura.

Steel structure and canopy, small aluminium cylinders, black fabric wire, steel hanging cable 2 mt, built-in driver.

CE □ IP20

| Voltage | Source | Watt | Lumen | CRI | Kelvin | Light beam |
|----------|------------|--------|---------|-----|--------|------------|
| 220-240V | Modulo led | 4x4,5W | 4x500Lm | >90 | 2700K | narrow |



Ø840xH300



| Corpo/Body | Riflettore/Reflector | Particolari/Details |
|--|----------------------|---|
| <ul style="list-style-type: none"> Acidatura scura Dark etched Acidatura chiara Light etched | - | <ul style="list-style-type: none"> Ottone naturale Natural brass Ottone brunito Burnished brass |

SOSPESE
PENDENTE



Versioni/Versions

Terra/Floor
pag. 76

Parete-Soffitto
Wall-Ceiling
pag. 274
pag. 280

Renzo Serafini
RENZO SERAFINI

TUBOLARE LED

10.017

Corpo e rosone in acciaio, cavo di alimentazione tessuto nero, sostegni in acciaio 2 mt, trasformatore incluso da installare remoto.

Steel structure and canopy, black fabric wire, steel hanging cable 2 mt, transformer included to be installed remotely.

A richiesta possibilità di installare il trasformatore in base 250x100xH50 mm.

Transformer can be installed in a 250x100xH50 mm base on demand.

CE □ IP20

| Voltage | Source | Watt | Lumen | CRI | Kelvin | Light beam |
|----------|----------------|---------|----------------------|-----|----------------|------------|
| 220-240V | Modulo lineare | 17,3W/m | 1700Lm/m 1810Lm/m | >90 | 2700K 3000K | medium |

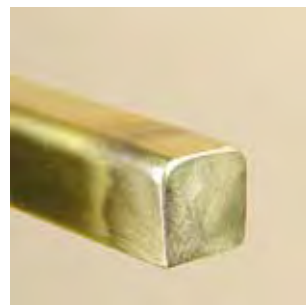

2000x25xH25

| Corpo/Body | | Riflet./Reflect. | Particolari/Details |
|--|---|------------------|---------------------|
| Ferro nero <i>Raw black iron</i> | Ferro v. <i>Iron p.</i> | - | - |
| Nero opaco v. <i>Matte black p.</i> | Ottone naturale <i>Natural brass</i> | | |

Versioni/Versions

Tavolo/Table
pag. 26

Terra/Floor
pag. 64
pag. 88

Parete-Soffitto
Wall-Ceiling
pag. 310

Ricaricabili
Rechargeable
pag. 424

SOSPESE
PENDENT



Renzo Serafini
RENZO SERAFINI



TUBOLARE LED
Ph. Patrizia Galliano
Project Martina Design

TUBOLARE NASCOSTO

10.067

Corpo in acciaio,
trasformatore integrato
in struttura.

Steel structure,
built-in transformer.

CE IP20

| Voltage | Source | Watt | Lumen | CRI | Kelvin | Light beam |
|----------|----------------|---------|----------------------|-----|----------------|------------|
| 220-240V | Modulo lineare | 17,3W/m | 1700Lm/m 1810Lm/m | >90 | 2700K 3000K | medium |

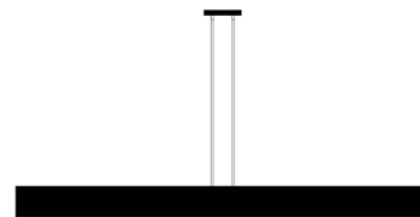
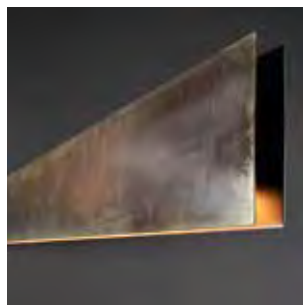

2000x35xH955

| Corpo/Body | Riflettore/Reflector | Particolari/Details |
|--|----------------------|---|
| <ul style="list-style-type: none"> Acidatura scura Dark etched Acidatura chiara Light etched | - | <ul style="list-style-type: none"> Ottone naturale Natural brass Ottone brunito Burnished brass |

SOSPESE
PENDENT

Renzo Serafini
RENZO SERAFINI

ALE 1800 Design by Angelo Sanzone

10.068

Corpo e rosone in acciaio, lamiera decorativa in ottone, cavo di alimentazione tessuto nero, sostegni in acciaio 2 mt, trasformatore integrato in struttura.

Steel structure and canopy, brass decorative plates, black fabric wire, steel hanging cable 2 mt, built-in transformer.

CE IP20

| Voltage | Source | Watt | Lumen | CRI | Kelvin | Light beam |
|----------|----------------|---------|----------|-----|--------|------------|
| 220-240V | Modulo lineare | 21,6W/m | 2050Lm/m | >95 | 2700K | medium |



1800x200xH120

| Corpo/Body | Riflettore/Reflector | Particolari/Details |
|--|--|--|
| <p>■ Ottone brunito v. <i>Burnished brass p.</i></p> | <p>■ Ottone naturale <i>Natural brass</i></p> <p>■ Ottone brunito <i>Burnished brass</i></p> <p>■ Ottone spazzolato <i>Brushed brass</i></p> | <p>■ Ottone naturale <i>Natural brass</i></p> <p>■ Ottone brunito <i>Burnished brass</i></p> |

SOSPESE
PENDENTE



Renzo Serafini
RENZO SERAFINI

CIOTOLA 500

10.066

Corpo e rosone in acciaio, cavo di alimentazione tessuto nero, sostegni in acciaio 2 mt, lampadina esclusa.

Steel structure and canopy, black fabric wire, steel hanging cable, bulb not included.

CE IP20

| Voltage | Source | Watt | Lumen | CRI | Kelvin | Light beam |
|----------|--------|----------|-------|-----|--------|------------|
| 220-240V | E27 | MAX 100W | - | - | - | - |



Ø500xH250

CIOTOLA 900

10.065



Ø900xH450

| Corpo/Body | Riflettore/Reflector | Particolari/Details |
|--|---|---|
| <ul style="list-style-type: none"> Acidatura scura Dark etched Acidatura chiara Light etched | <ul style="list-style-type: none"> Oro aranciato v. Orange gold p. Acidatura scura Dark etched Acidatura chiara Light etched | <ul style="list-style-type: none"> Ottone naturale Natural brass Ottone brunito Burnished brass |

Versioni/Versions

Tavolo/Table

pag. 48
pag. 50

SOSPESE
PENDENT



Renzo Serafini
RENZO SERAFINI



CIOTOLA 900
Private residence

BICCHIERE TONDO SOSPESO

10.049

Cilindro in alluminio od ottone, rosone in acciaio od ottone, cavo di alimentazione tessuto nero 2 mt, lampadina esclusa.

Aluminium or brass cylinder, steel or brass canopy, black fabric wire 2 mt, bulb not included.

CE IP20

| Voltage | Source | Watt | Lumen | CRI | Kelvin | Light beam |
|----------|--------|---------|-------|-----|--------|------------|
| 220-240V | GU10 | MAX 10W | - | - | - | - |



Ø60xH120

| Corpo/Body | | Riflettore/Reflector | Particolari/Details |
|---------------------------------|-----------------------------------|------------------------------------|-----------------------------------|
| Ferro v. Iron p. | Ottone naturale Natural brass | Oro aranciato v. Orange gold p. | Ottone naturale Natural brass |
| Nero opaco v. Matte black p. | Ottone brunito Burnished brass | Ferro v. Iron p. | Ottone brunito Burnished brass |
| | | Nero opaco v. Matte black p. | |

Versioni/Versions

Tavolo/Table
pag. 32

Terra/Floor
pag. 70
pag. 84

Sospese/Pendent
pag. 144
pag. 200

Parete-Soffitto
Wall-Ceiling

pag. 260
pag. 268
pag. 290
pag. 300
pag. 302

SOSPESE
PENDENT



Renzo Serafini
RENZO SERAFINI



BICCHIERE TONDO
CUSTOM
Project Anton Cristell
For Aromi Group
Il Pagliaccio Restaurant

PUNTO DI VISTA CORDA

10.004

Corpo in alluminio,
rosone in acciaio,
cavo di alimentazione
tessuto nero 1 mt,
driver integrato in
struttura.

*Aluminium structure,
steel canopy, black
fabric wire 1 mt,
built-in driver.*

CE IP20

| Voltage | Source | Watt | Lumen | CRI | Kelvin | Light beam |
|----------|------------|------|----------------|-----|----------------|------------|
| 220-240V | Modulo led | 3W | 350Lm 375Lm | >90 | 2700K 3000K | narrow |

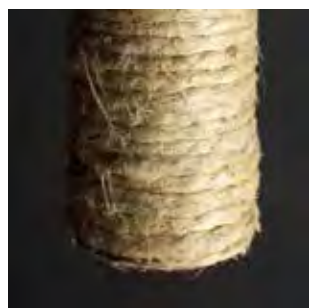

Ø30xH1000

| Corpo/Body | Riflettore/Reflector | Particolari/Details |
|---|----------------------|---------------------|
|  Corda, Ferro nero String, Raw black iron | - | - |

SOSPESA
PENDENT

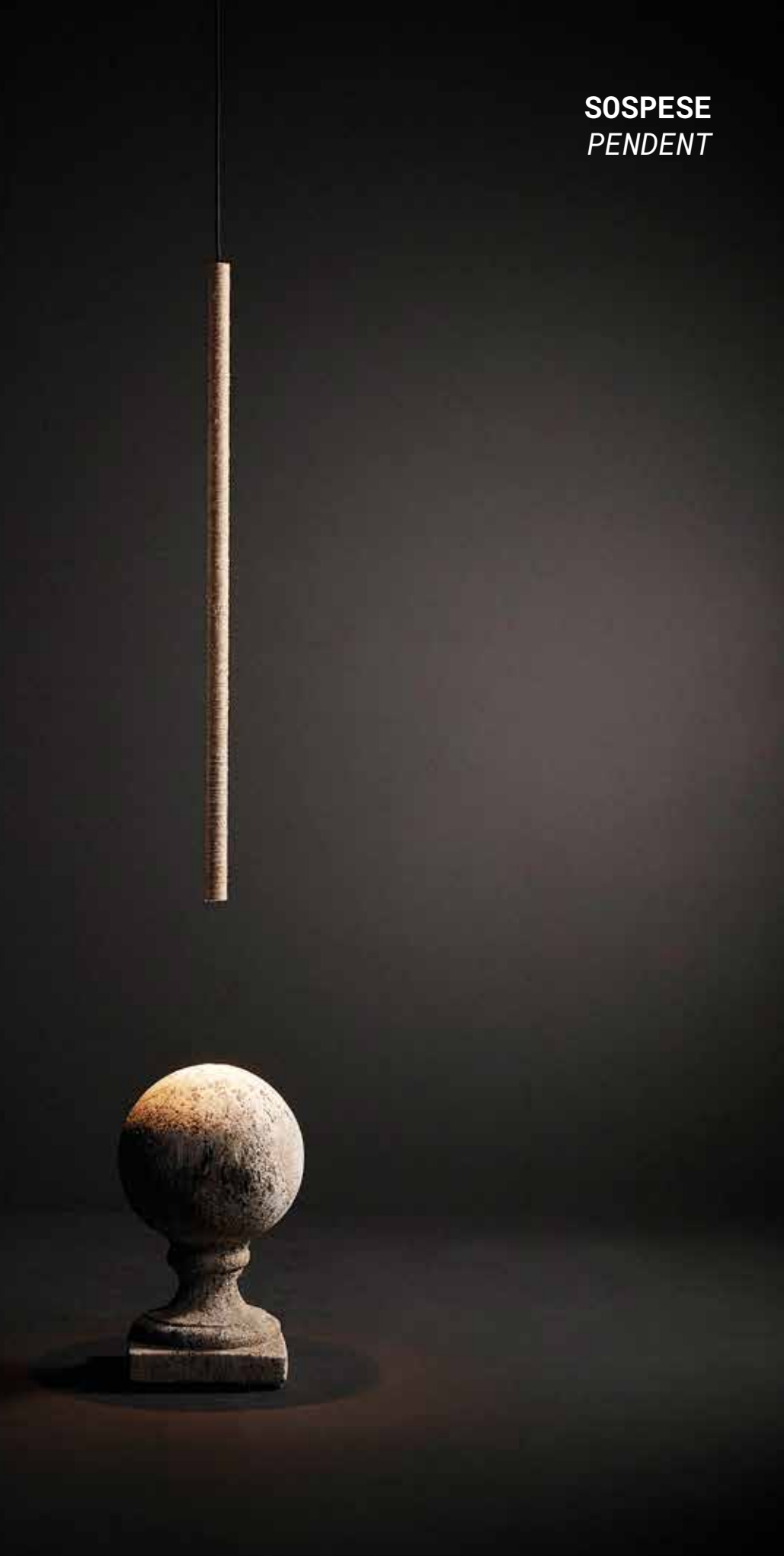

Renzo Serafini
RENZO SERAFINI

TUBO DI LUCE

10.040

Cilindro e rosone in ottone, diffusore in plexiglass satinato, cavo di alimentazione tessuto nero 2 mt, lampadina inclusa.





Brass cylinder and canopy, frosted plexiglass diffusor, black fabric wire 2 mt, bulb included.

CE IP20

| Voltage | Source | Watt | Lumen | CRI | Kelvin | Light beam |
|----------|-----------|------|-------|-----|--------|------------|
| 220-240V | GU10 dimm | 7W | 510Lm | >80 | 2700K | medium |



Ø60xH600
Ø60xH800

| Corpo/Body | | Riflet./Reflec. | Particolari/Details |
|--|---|-----------------|--|
|  Ottone naturale <i>Natural brass</i> |  Ottone spazzolato <i>Brushed brass</i> | - |  Ottone naturale <i>Natural brass</i> |
|  Ottone brunito <i>Burnished brass</i> | | |  Ottone brunito <i>Burnished brass</i> |

Versioni/Versions

Parete-Soffitto
Wall-Ceiling

pag. 284

SOSPESE
PENDENT

Renzo Serafini
RENZO SERAFINI

TUBO DI LUCE
Private residence



ORIENTE Design by Giovanni Cenni Studio

10.061

Corpo in alluminio, rosone in acciaio, cilindro in legno di frassino, cilindro e asta in ottone, paralume cilindrico, cavo di alimentazione tessuto nero 2 mt, doppia accensione, trasformatori integrati in struttura.

Aluminium structure, steel canopy, ash wood cylinder, brass cylinder and rod, cylindrical lampshade, black fabric wire 2 mt, double ignition, built-in transformers.

CE IP20

| Voltage | Source | Watt | Lumen | CRI | Kelvin | Light beam |
|----------|------------------------------|--------------|------------------|-----|--------|------------|
| 220-240V | Modulo lineare Modulo led | 9,6W/m 5W | 745Lm/m 490Lm | >90 | 2700K | wide |



Ø300xH500

| Corpo/Body | Riflettore/Reflector | Particolari/Details |
|---|-----------------------------------|---|
| Legno, Ottone naturale, Nero opaco v. <i>Wood, Natural brass, Matte black p.</i> | Lino avorio <i>Ivory linen</i> | Ottone naturale <i>Natural brass</i> |

ORIENTE MAXI Design by Giovanni Cenni Studio

10.062

Corpo in alluminio, rosone e asta in acciaio, paralume cilindrico, lampadina inclusa, doppia accensione, trasformatore integrato in struttura.

Aluminium structure, steel canopy and rod, cylindrical lampshade, bulb included, double ignition, built-in transformer.

CE IP20

| Voltage | Source | Watt | Lumen | CRI | Kelvin | Light beam |
|----------|------------------------------|---------------|------------------|------------|--------|------------|
| 220-240V | Modulo lineare AR111 dimm | 9,6W/m 13W | 745Lm/m 880Lm | >90 >80 | 2700K | wide |



Ø500xH1340

| Corpo/Body | Riflettore/Reflector | Particolari/Details |
|--|-----------------------------------|--|
| Nero opaco v. <i>Matte black p.</i> | Lino avorio <i>Ivory linen</i> | Ottone brunito <i>Burnished brass</i> |

Versioni/Versions

Parete-Soffitto
 Wall-Ceiling

pag. 324
 pag. 326

SOSPESE
 PENDENT



Renzo Serafini
 RENZO SERAFINI



ORIENTE MAXI

Project Giovanni Cenni Studio
Sushi Dome Restaurant

TESSUTO WOOD

Design by Giovanni Cenni Studio
10.054

Cilindro in legno di frassino, rosone in ottone, paralume cilindrico, cavo di alimentazione tessuto nero 2 mt, doppia accensione, trasformatori integrati in struttura.



Ash wood cylinder, brass canopy, cylindrical lampshade, black fabric wire 2 mt, double ignition, built-in transformers.

CE  IP20

| Voltage | Source | Watt | Lumen | CRI | Kelvin | Light beam |
|----------|------------------------------|--------------|------------------|------------|--------|------------|
| 220-240V | Modulo lineare Modulo led | 9,6W/m 5W | 745Lm/m 490Lm | >90 >80 | 2700K | wide |



Ø200xH470

| Corpo/Body | Riflettore/Reflector | Particolari/Details |
|---|--|--|
|  Legno, Ottone naturale Wood, Natural brass |  Lino avorio Ivory linen |  Ottone naturale Natural brass |

Versioni/Versions

Terra/Floor

pag. 104
pag. 108

Parete-Soffitto
Wall-Ceiling

pag. 324
pag. 326

SOSPESE
PENDENT



Renzo Serafini
RENZO SERAFINI

CILINDRO PASSANTE SU DISCO

10.034

Cilindro e rosone in ottone, disco in acciaio, cavo di alimentazione tessuto nero 2 mt, lampadina inclusa.

Brass cylinder and canopy, steel plate, black fabric wire 2 mt, bulb included.

CE IP20

| Voltage | Source | Watt | Lumen | CRI | Kelvin | Light beam |
|----------|-----------|------|-------|-----|--------|------------|
| 220-240V | GU10 dimm | 7W | 510Lm | >80 | 2700K | medium |



Ø250xH180

| Corpo/Body | | Riflettore/Reflector | Part./Det. |
|--|---|--|------------|
| Ottone naturale <i>Natural brass</i> | Ottone spazzolato <i>Brushed brass</i> | Nero opaco v. <i>Matte black p.</i> | - |
| Ottone brunito <i>Burnished brass</i> | | | |

CILINDRO PASSANTE SU TESSUTO

10.036

Corpo e rosone in ottone, paralume cilindrico, cavo di alimentazione tessuto nero 2 mt, lampadina inclusa.

Brass structure and canopy, cylindrical lampshade, black fabric wire 2 mt, bulb included.

CE IP20

| Voltage | Source | Watt | Lumen | CRI | Kelvin | Light beam |
|----------|-----------|------|-------|-----|--------|------------|
| 220-240V | GU10 dimm | 7W | 510Lm | >80 | 2700K | medium |



Ø250xH230

| Corpo/Body | | Riflettore/Reflector | Part./Det. |
|--|---|---------------------------------|------------|
| Ottone naturale <i>Natural brass</i> | Ottone spazzolato <i>Brushed brass</i> | Lino nero <i>Black linen</i> | - |
| Ottone brunito <i>Burnished brass</i> | | | |

Versioni/Versions

Terra/Floor

pag. 102
pag. 104

Parete-Soffitto
Wall-Ceiling

pag. 324
pag. 326

SOSPESE
PENDENT



Renzo Serafini
RENZO SERAFINI

POESIA Design by Giovanni Cenni Studio
10.063

Corpo in acciaio,
cilindro piccolo in
ottone, paralume
cilindrico,
lampadina inclusa,
doppia accensione,
trasformatore integrato
in struttura.

Steel structure,
small brass cylinder,
cylindrical lampshade,
bulb included, double
ignition, built-in
transformer.

CE IP20

| Voltage | Source | Watt | Lumen | CRI | Kelvin | Light beam |
|----------|---------------------------------|---------------|------------------|------------|--------|------------|
| 220-240V | Modulo lineare AR111 dimm | 9,6W/m 13W | 745Lm/m 880Lm | >90 >80 | 2700K | wide |

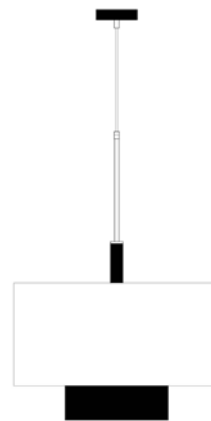
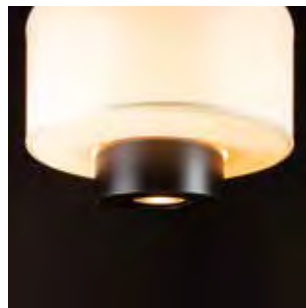

Ø500xH1400

| Corpo/Body | Riflettore/Reflector | Particolari/Details |
|---|--|--|
|  Nero opaco v., Ottone naturale Matte black p., Natural brass |  Lino avorio Ivory linen |  Ottone naturale Natural brass |

Versioni/Versions

Terra/Floor
pag. 108

Parete-Soffitto
Wall-Ceiling
pag. 324
pag. 326

SOSPESE
PENDENT



Renzo Serafini
RENZO SERAFINI



POESIA

Project Giovanni Cenni Studio
Da Lele Restaurant

SILENZIO

Design by Giovanni Cenni Studio
10.064



Corpo in acciaio,
paralumi cilindrici,
lampadine incluse,
doppia accensione,
trasformatore integrato
in struttura.
Steel structure,
cylindrical lampshades,
bulbs included, double
ignition, built-in
transformer.

CE IP20

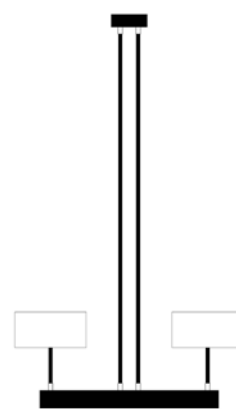
| Voltage | Source | Watt | Lumen | CRI | Kelvin | Light beam |
|----------|-------------------------|-----------------|---------------------|------------|--------|------------|
| 220-240V | Modulo lineare E14 dimm | 17,3W/m 2x5W | 1700Lm/m 2x470Lm | >90 >80 | 2700K | wide |



650x200xH1100

| Corpo/Body | Riflettore/Reflector | Particolari/Details |
|---|--|--|
|  Nero opaco v. Matte black p. |  Lino avorio Ivory linen |  Ottone naturale Natural brass |

Versioni/Versions

Terra/Floor
pag. 108

Parete-Soffitto
Wall-Ceiling
pag. 324
pag. 326



SOSPESE PENDENT

Renzo Serafini
RENZO SERAFINI



SILENZIO

Project Giovanni Cenni Studio
Da Lele Restaurant

RILUCE

10.005

Cilindro e rosone in acciaio od ottone, cavo di alimentazione tessuto nero 2 mt, vetro decorativo trasparente, lampadina inclusa.

Steel or brass cylinder and canopy, black fabric wire 2 mt, transparent decorative glass, bulb included.

Possibili alternative vetri.

Possible glass alternatives.



Ø130xH225

Ø125

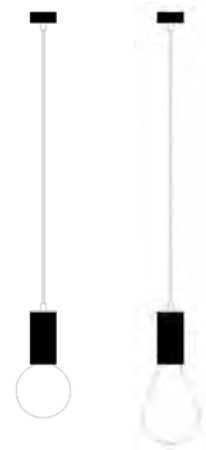

Ø125xH240

Ø130xH340

CE IP20

| Voltage | Source | Watt | Lumen | CRI | Kelvin | Light beam |
|----------|-----------|------|---------|-----|--------|------------|
| 220-240V | GU10 dimm | 2x7W | 2x510Lm | >80 | 2700K | medium |



| Corpo/Body | | Riflet./Reflec. | Particolari/Details |
|--|---|-----------------|--|
| Ferro nero <i>Raw black iron</i> | Ottone spazzolato <i>Brushed brass</i> | - | Ottone naturale <i>Natural brass</i> |
| Ottone brunito <i>Burnished brass</i> | | | Ottone brunito <i>Burnished brass</i> |

Versioni/Versions

Parete-Soffitto
Wall-Ceiling

pag. 378
pag. 382

SOSPESE PENDENT

Renzo Serafini
RENZO SERAFINI

CONO RILUCE

10.032

Corpo in alluminio,
rosone in acciaio,
cavo di alimentazione
tessuto nero 2 mt,
vetro decorativo
trasparente, driver
integrato in struttura.

*Aluminium structure,
steel canopy, black
fabric wire 2 mt,
transparent decorative
glass, built-in driver.*

CE IP20

| Voltage | Source | Watt | Lumen | CRI | Kelvin | Light beam |
|----------|------------|------|----------------|-----|----------------|------------|
| 220-240V | Modulo led | 3W | 350Lm 375Lm | >90 | 2700K 3000K | narrow |



Ø125xH290

| Corpo/Body | Riflet./Reflect. | Part./Det. |
|--|------------------|------------|
| <div style="display: flex; gap: 10px;"> <div style="display: flex; align-items: center;"> <div style="width: 15px; height: 15px; background-color: black; margin-right: 5px;"></div> Acidatura scura Dark etched </div> <div style="display: flex; align-items: center;"> <div style="width: 15px; height: 15px; background-color: #808080; margin-right: 5px;"></div> Acidatura chiara Light etched </div> </div> | - | - |

SOSPENSE
PENDENT



Renzo Serafini
RENZO SERAFINI

LUCE DA MARE Design by Giovanni Cenni Studio

10.058

Corpo in alluminio,
rosone in acciaio,
cavo di alimentazione
tessuto nero 2 mt,
vetro decorativo
trasparente, lampadina
inclusa.



*Aluminium structure,
steel canopy, black
fabric wire 2 mt,
transparent decorative
glass, bulb included.*

CE IP20

| Voltage | Source | Watt | Lumen | CRI | Kelvin | Light beam |
|----------|-----------|------|-------|-----|--------|------------|
| 220-240V | GU10 dimm | 7W | 510Lm | >80 | 2700K | medium |



Ø280xH490

| Corpo/Body | Riflettore/Reflector | Particolari/Details |
|--|----------------------|--|
|  Crema v. Cream p. | - |  Ottone naturale Natural brass |

SOSPESE
PENDENTE



Versioni/Versions

Tavolo/Table
pag. 40

Parete-Soffitto
Wall-Ceiling
pag. 346



Renzo Serafini
RENZO SERAFINI

LOCCHIO

10.018

Corpo in alluminio,
rosone in acciaio,
cavo di alimentazione
tessuto nero 2 mt,
lampadina inclusa.

*Aluminium structure,
steel canopy, black
fabric wire 2 mt, bulb
included.*



CE IP20

| Voltage | Source | Watt | Lumen | CRI | Kelvin | Light beam |
|----------|----------|------|-------|-----|--------|------------|
| 220-240V | E27 dimm | 5,5W | 490Lm | >90 | 2500K | wide |



Ø180xH300

| Corpo/Body | Riflettore/Reflector | Particolari/Details |
|---|----------------------|---|
| <ul style="list-style-type: none"> Acidatura scura <i>Dark etched</i> Acidatura chiara <i>Light etched</i> | - | <ul style="list-style-type: none"> Ottone naturale <i>Natural brass</i> Ottone brunito <i>Burnished brass</i> |

SOSPESE
PENDENT



Renzo Serafini
RENZO SERAFINI

SOLE BASSO

10.043

Corpo e rosone in ottone, cavo di alimentazione tessuto nero 2 mt, lampadina inclusa.





Brass structure and canopy, black fabric wire 2 mt, bulb included.

CE IP20

| Voltage | Source | Watt | Lumen | CRI | Kelvin | Light beam |
|----------|----------|------|----------------|------------|--------|------------|
| 220-240V | E27 dimm | 4W | 190Lm 100Lm | >90 >80 | 2200K | wide |



Ø280xH500

| Corpo/Body | | Riflet./Reflec. | Particolari/Details |
|--|---|-----------------|--|
|  Ottone naturale <i>Natural brass</i> |  Ottone spazzolato <i>Brushed brass</i> | - |  Ottone naturale <i>Natural brass</i> |
|  Ottone brunito <i>Burnished brass</i> | | |  Ottone brunito <i>Burnished brass</i> |

Versioni/Versions

Terra/Floor
pag. 114

Parete-Soffitto
Wall-Ceiling
pag. 362
pag. 364

SOSPESE
PENDENT



Renzo Serafini
RENZO SERAFINI

MEXICAL 250

10.008

Corpo e rosone in acciaio, cavo di alimentazione tessuto nero 2 mt, lampadina esclusa.

Steel structure and canopy, black fabric wire 2 mt, bulb not included.

CE IP20

| Voltage | Source | Watt | Lumen | CRI | Kelvin | Light beam |
|----------|--------|---------|-------|-----|--------|------------|
| 220-240V | E27 | MAX 60W | - | - | - | - |



Ø250xH60

MEXICAL 400

10.016



Ø400xH60

| Corpo/Body | Riflettore/Reflector | Particolari/Details |
|--|----------------------|---|
| <ul style="list-style-type: none"> Ferro v. Iron p. Corten Corten | - | <ul style="list-style-type: none"> Ottone naturale Natural brass Ottone brunito Burnished brass |

SOSPESE
PENDENTE

Versioni/Versions

Terra/Floor

pag. 122

pag. 124

Parete-Soffitto

Wall-Ceiling

pag. 342

pag. 344

Renzo Serafini
RENZO SERAFINI



MEXICAL

Ph. Stefano Borghesi
Relais San Vigilio

ISOLATORE 100 10.013

Corpo e rosone in acciaio, cilindro piccolo in ottone, cavo di alimentazione tessuto nero 2 mt, driver integrato in struttura.

Steel structure and canopy, small brass cylinder, black fabric wire 2 mt, built-in driver.

CE IP20

| Voltage | Source | Watt | Lumen | CRI | Kelvin | Light beam |
|----------|------------|------|-------|-----|--------|------------|
| 220-240V | Modulo led | 1,7W | 170Lm | >80 | 2700K | narrow |



ISOLATORE 250 10.003

Corpo e rosone in acciaio, cilindro piccolo in alluminio od ottone, cavo di alimentazione tessuto nero 2 mt, driver integrato in struttura.

Steel structure and canopy, small aluminium or brass cylinder, black fabric wire 2 mt, built-in driver.

CE IP20

| Voltage | Source | Watt | Lumen | CRI | Kelvin | Light beam |
|----------|------------|------|-------|-----|--------|------------|
| 220-240V | Modulo led | 3W | 350Lm | >90 | 2700K | narrow |



| Corpo/Body | | Riflet./Reflec. | Particolari/Details |
|----------------------------------|---------------------------------|-----------------|-----------------------------------|
| Acidatura scura Dark etched | Nero opaco v. Matte black p. | - | Ottone naturale Natural brass |
| Acidatura chiara Light etched | Corten | | Ottone brunito Burnished brass |

Versioni/Versions

Parete-Soffitto
Wall-Ceiling
pag. 332

SOSPESE
PENDENT



Renzo Serafini
RENZO SERAFINI



ISOLATORE 250
CUSTOM

Ph. Stefano Borghesi
Relais San Vigilio



ISOLATORE 250

Project Alessia Garibaldi
Velabro Hotel
Roma

GOCCIA DI VETRO

10.033.MINI

Vetro soffiato di forma artistica, cilindro piccolo in alluminio, rosone in acciaio, cavo di alimentazione 2 mt, driver integrato in struttura.

Artistic blown glass, small aluminium cylinder, steel canopy, black wire 2 mt, built-in driver.

GOCCIA DI VETRO MINI

CE IP20

| Voltage | Source | Watt | Lumen | CRI | Kelvin | Light beam |
|----------|------------|------|-------|-----|--------|------------|
| 220-240V | Modulo led | 3W | 350Lm | >90 | 2700K | narrow |



Ø180xH320

10.033.MAXI

Vetro soffiato di forma artistica, cilindro grande in alluminio, rosone in acciaio, catena 2 mt, cavo di alimentazione 2 mt, lampadina inclusa.

Artistic blown glass, big aluminium cylinder, steel canopy, 2 mt chain black wire 2 mt, bulb included.



GOCCIA DI VETRO MAXI

CE IP20

| Voltage | Source | Watt | Lumen | CRI | Kelvin | Light beam |
|----------|------------|------|--------|-----|--------|------------|
| 220-240V | AR111 dimm | 17W | 1700Lm | >90 | 2700K | wide |



Ø280xH500

| Corpo/Body | Riflettore/Reflector | Particolari/Details |
|---|----------------------|--|
|  Nero opaco v. Matte black p. | - |  Ottone naturale Natural brass |

SOSPESE
PENDENT

Renzo Serafini
RENZO SERAFINI

AMPOLLA E27

10.019

Vetro pirex a forma di calice, rosone in acciaio, cavo di alimentazione tessuto nero 2 mt, lampadina esclusa.

Pyrex chalice shaped glass, steel canopy, black fabric wire 2 mt, bulb not included.

CE IP20

| Voltage | Source | Watt | Lumen | CRI | Kelvin | Light beam |
|----------|--------|---------|-------|-----|--------|------------|
| 220-240V | E27 | MAX 60W | - | - | - | - |



Ø200xH260

| Corpo/Body | Riflettore/Reflector | Particolari/Details |
|--|----------------------|--|
|  Ferro nero Raw black iron | - |  Ottone naturale Natural brass |

SOSPESE
PENDENTE



Renzo Serafini
RENZO SERAFINI



AMPOLLA
Private residence

LUCE FUORI

10.046

Cilindro in alluminio, rosone in acciaio, cavo di alimentazione tessuto nero 2 mt, vetro decorativo, lampadina inclusa.

Aluminium cylinder, steel canopy, black fabric wire 2 mt, decorative glass, bulb included.

CE IP20

| Voltage | Source | Watt | Lumen | CRI | Kelvin | Light beam |
|----------|-----------|------|-------|-----|--------|------------|
| 220-240V | GU10 dimm | 7W | 510Lm | >80 | 2700K | medium |

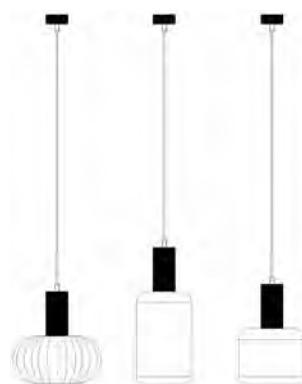

Ø135xH370
Ø130xH270
Ø200xH260

| Corpo/Body | Riflettore/Reflector | Particolari/Details |
|---------------------------------|----------------------|---|
| Nero opaco v. Matte black p. | - | Ottone naturale Natural brass Ottone brunito Burnished brass |

Versioni/Versions

Parete-Soffitto
Wall-Ceiling
pag. 368

SOSPESE
PENDENT



Renzo Serafini
RENZO SERAFINI

LUCE DENTRO

10.047

Cilindro in alluminio,
rosone in acciaio,
cavo di alimentazione
tessuto nero 2 mt,
vetro decorativo.



*Aluminium cylinder,
steel canopy, black
fabric wire 2 mt,
decorative glass.*

CE □ IP20

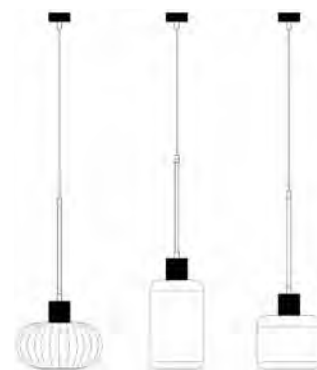
| Voltage | Source | Watt | Lumen | CRI | Kelvin | Light beam |
|----------|-----------------|------|-------|-----|--------|------------|
| 220-240V | Modulo led dimm | 4,5W | 500Lm | >80 | 2700K | wide |



Ø135xH280
Ø130xH180
Ø200xH170

| Corpo/Body | Riflettore/Reflector | Particolari/Details |
|---|----------------------|---|
|  Nero opaco v. Matte black p. | - |  Ottone naturale Natural brass  Ottone brunito Burnished brass |

Versioni/Versions

Parete-Soffitto
Wall-Ceiling
pag. 368

SOSPESE
PENDENT



Renzo Serafini
RENZO SERAFINI

ANTENNA CON BICCHIERI

10.039

Corpo in acciaio,
cilindri in alluminio,
lampadine incluse.

Steel structure,
aluminium cylinders,
bulbs included.

CE IP20

| Voltage | Source | Watt | Lumen | CRI | Kelvin | Light beam |
|----------|-----------|------|---------|-----|--------|------------|
| 220-240V | GU10 dimm | 5x7W | 5x510Lm | >80 | 2700K | medium |



1205x1605xH1000



| Corpo/Body | Riflettore/Reflector | Particolari/Details |
|--|---|---|
|  Ottone satinato v. Satin brass p. |  Ottone satinato Satin brass |  Ottone naturale Natural brass |
|  Nero opaco v. Matte black p. |  Nero opaco v. Matte black p. |  Ottone brunito Burnished brass |

SOSPESE
PENDENT

Versioni/Versions

Tavolo/Table
pag. 32

Terra/Floor
pag. 70
pag. 84

Parete-Soffitto
Wall-Ceiling
pag. 260
pag. 268
pag. 290
pag. 300
pag. 302

Renzo Serafini
RENZO SERAFINI



PIEGA CHANDELLIER

10.060

Corpo in ottone,
trasformatore integrato
in struttura.

*Brass structure,
built-in transformer.*

CE IP20

| Voltage | Source | Watt | Lumen | CRI | Kelvin | Light beam |
|----------|----------------|---------|------------|-----|--------|------------|
| 220-240V | Modulo lineare | 3x11W/m | 3x1360Lm/m | >85 | 3000K | medium |



Ø250xH1300

| Corpo/Body | Riflettore/Reflector | Particolari/Details |
|--|--|--|
|  Ottone naturale <i>Natural brass</i> |  Ottone naturale <i>Natural brass</i> |  Ottone naturale <i>Natural brass</i> |
|  Ottone brunito <i>Burnished brass</i> |  Ottone brunito <i>Burnished brass</i> |  Ottone brunito <i>Burnished brass</i> |

SOSPESE
PENDENT



Versioni/Versions

Tavolo/Table
pag. 54

Parete-Soffitto
Wall-Ceiling
pag. 356
pag. 358
pag. 360

Renzo Serafini
RENZO SERAFINI

GHIANDA

10.026

Corpo e rosone in ottone, cavo di alimentazione tessuto nero 2 mt, vetro decorativo trasparente, lampadina inclusa.

Brass structure and canopy, black fabric wire 2 mt, transparent decorative glass, bulb included.

CE □ IP20

| Voltage | Source | Watt | Lumen | CRI | Kelvin | Light beam |
|----------|---------|------|-------|-----|--------|------------|
| 220-240V | G9 dimm | 3,5W | 320Lm | >90 | 2700K | medium |



Ø160xH430

| Corpo/Body | Riflettore/Reflector | Particolari/Details |
|---|---|--|
|  Ottone naturale <i>Natural brass</i> |  Ottone naturale <i>Natural brass</i> |  Ottone naturale <i>Natural brass</i> |
|  Ottone naturale <i>Natural brass</i> |  Ottone naturale <i>Natural brass</i> |  Ottone brunito <i>Burnished brass</i> |
|  Ottone spazzolato <i>Brushed brass</i> |  Ottone spazzolato <i>Brushed brass</i> | |

Versioni/Versions

Tavolo/Table
pag. 125

Terra/Floor
pag. 116

Parete-Soffitto
Wall-Ceiling
pag. 346
pag. 348

SOSPESE
PENDENT



Renzo Serafini
RENZO SERAFINI

GHIANDA 4X

10.026.4X

Corpo in ottone, vetri decorativi satinati, lampadine incluse.

Brass structure, frosted decorative glass, bulbs included.

CE IP20

| Voltage | Source | Watt | Lumen | CRI | Kelvin | Light beam |
|----------|----------|------|---------|-----|--------|------------|
| 220-240V | E27 dimm | 4x5W | 4x470Lm | >90 | 2700K | wide |

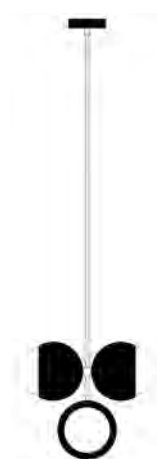

325x325xH1100

| Corpo/Body | Riflettore/Reflector | Particolari/Details |
|--|--|---|
|  Ottone naturale Natural brass |  Ottone naturale Natural brass |  Ottone naturale Natural brass |
|  Ottone naturale Natural brass |  Ottone naturale Natural brass |  Ottone brunito Burnished brass |
|  Ottone spazzolato Brushed brass |  Ottone spazzolato Brushed brass | |

Versioni/Versions

Tavolo/Table
pag. 125

Terra/Floor
pag. 116

Parete-Soffitto
Wall-Ceiling
pag. 346
pag. 348

SOSPESE
PENDENT



Renzo Serafini
RENZO SERAFINI

GHIANDA 8X

10.026.8X

Corpo in ottone, vetri decorativi satinati, lampadine incluse.

Brass structure, frosted decorative glass, bulbs included.

CE IP20

| Voltage | Source | Watt | Lumen | CRI | Kelvin | Light beam |
|----------|----------|------|---------|-----|--------|------------|
| 220-240V | E27 dimm | 8x5W | 8x470Lm | >90 | 2700K | wide |



1100x1600xH1000

| Corpo/Body | Riflettore/Reflector | Particolari/Details |
|--|--|---|
|  Ottone naturale Natural brass |  Ottone naturale Natural brass |  Ottone naturale Natural brass |
|  Ottone naturale Natural brass |  Ottone naturale Natural brass |  Ottone brunito Burnished brass |
|  Ottone spazzolato Brushed brass |  Ottone spazzolato Brushed brass | |

Versioni/Versions

Tavolo/Table
pag. 125

Terra/Floor
pag. 116

Parete-Soffitto
Wall-Ceiling
pag. 346
pag. 348

SOSPESE
PENDENT



Renzo Serafini
RENZO SERAFINI

BARRA IMBUTO 4X

10.028

Corpo in ottone,
imbuti in alluminio,
lampadine escluse.

Brass structure,
aluminium reflectors,
bulbs not included.





CE IP20

| Voltage | Source | Watt | Lumen | CRI | Kelvin | Light beam |
|----------|--------|---------|-------|-----|--------|------------|
| 220-240V | GU10 | MAX 10W | - | - | - | - |



2000x1000xH900



| Corpo/Body | Riflettore/Reflector | Particolari/Details |
|--|--|--|
|  Ottone spazzolato, Rame brunito v. Brushed brass, Burnished copper p. |  Oro aranciato v. Orange gold p. |  Ottone naturale Natural brass |
| |  Rame brunito v. Burnished copper p. | |

SOSPESE
PENDENT



Versioni/Versions

Tavolo/Table
pag. 38

Terra/Floor
pag. 100

Parete-Soffitto
Wall-Ceiling
pag. 316
pag. 320
pag. 322



Renzo Serafini
RENZO SERAFINI



BARRA IMBUTO 4X

Ph. Simone Cocco
Project Stefano Toscano
e Valentina Pelizzatti
Poormanger Bistrot
Torino

IMBUTO CHANDELLIER

10.027

Corpo e rosone in acciaio, imbuto in alluminio, catena brunita 500 mm, lampadine escluse.

Steel structure and canopy, aluminium reflectors, 500 mm burnished chain, bulbs not included.

CE IP20

| Voltage | Source | Watt | Lumen | CRI | Kelvin | Light beam |
|----------|--------|---------|-------|-----|--------|------------|
| 220-240V | GU10 | MAX 10W | - | - | - | - |



1000x1000xH1125

| Corpo/Body | Riflettore/Reflector | Particolari/Details |
|---|--|---|
| <ul style="list-style-type: none"> Acidatura scura Dark etched Acidatura chiara Light etched | <ul style="list-style-type: none"> Oro aranciato v. Orange gold p. Acidatura scura Dark etched Acidatura chiara Light etched | <ul style="list-style-type: none"> Ottone naturale Natural brass Ottone brunito Burnished brass |

SOSPESE
PENDENT

Versioni/Versions

Tavolo/Table
pag. 38

Terra/Floor
pag. 100

Parete-Soffitto
Wall-Ceiling
pag. 316
pag. 320
pag. 322

Renzo Serafini
RENZO SERAFINI

IMPERFETTO

10.029

Corpo in acciaio,
riflettori
in alluminio,
lampadine escluse.

Steel structure,
aluminium reflectors,
bulbs not included.

CE IP20

| Voltage | Source | Watt | Lumen | CRI | Kelvin | Light beam |
|----------|--------|---------|-------|-----|--------|------------|
| 220-240V | GU10 | MAX 10W | - | - | - | - |

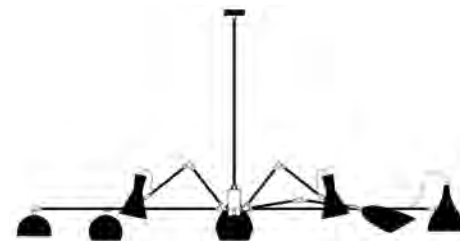

1400x1800xH800



| Corpo/Body | Riflettore/Reflector | Particolari/Details |
|--|---|---|
| <ul style="list-style-type: none"> Acidatura scura Dark etched Acidatura chiara Light etched | <ul style="list-style-type: none"> Oro aranciato v. Orange gold p. Acidatura scura Dark etched Acidatura chiara Light etched | <ul style="list-style-type: none"> Ottone naturale Natural brass Ottone brunito Burnished brass |

SOSPESE
PENDENT



Renzo Serafini
RENZO SERAFINI

SFERA 4X CHANDELLIER

10.038

Corpo in acciaio, sfere decorative biancolatte, lampadine incluse.



Steel structure, opal decorative spheres, bulbs included.

CE IP20

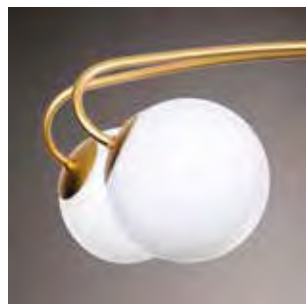
| Voltage | Source | Watt | Lumen | CRI | Kelvin | Light beam |
|----------|----------|------|---------|-----|--------|------------|
| 220-240V | E14 dimm | 4x5W | 4x470Lm | >80 | 2700K | wide |



850x400xH1300

| Corpo/Body | Riflettore/Reflector | Particolari/Details |
|--|----------------------|--|
|  Ottone satinato v. Satin brass p. | - |  Ottone naturale Natural brass |

Versioni/Versions

Tavolo/Table

pag. 56

Terra/Floor

pag. 116

Parete-Soffitto

Wall-Ceiling

pag. 334

pag. 336

pag. 338

pag. 340

SOSPESE
PENDENT



Renzo Serafini
RENZO SERAFINI

SFERA 6X SU MANIGLIA

10.044

Corpo in acciaio, sfere decorative biancolatte, lampadine incluse.





Steel structure, opal decorative spheres, bulbs included.

CE IP20

| Voltage | Source | Watt | Lumen | CRI | Kelvin | Light beam |
|----------|----------|------|---------|-----|--------|------------|
| 220-240V | E14 dimm | 6x5W | 6x470Lm | >80 | 2700K | wide |



2000x360xH910

| Corpo/Body | | Rifl./Refl. | Particolari/Details |
|--|--|-------------|--|
|  Ottone satinato v. Satin brass p. |  Ottone spazzolato Brushed brass | - |  Ottone spazzolato Brushed brass |
|  Ottone brunito Burnished brass | | |  Ottone brunito Burnished brass |

Versioni/Versions

Tavolo/Table
pag. 56

Terra/Floor
pag. 116

Parete-Soffitto
Wall-Ceiling
pag. 334
pag. 336
pag. 338
pag. 340

SOSPESE
PENDENT



Renzo Serafini
RENZO SERAFINI



SFERA 6X SU MANIGLIA

Ph. Nicolò Brunelli
Consorzio Noble Corner

STELLA ARTICOLATA

10.030

Corpo in acciaio, cilindri piccoli in alluminio, lampadine escluse, tripla accensione, driver integrato in struttura.

Steel structure, small aluminium cylinders, bulbs not included, triple ignition, built-in driver.

CE IP20

| Voltage | Source | Watt | Lumen | CRI | Kelvin | Light beam |
|----------|---------------------------|-----------------------------|-----------------|---------------|-----------------|------------|
| 220-240V | Modulo led E27 GU10 | 3x3W MAX 100W MAX 10W | 350Lm - - | >90 - - | 2700K - - | wide |

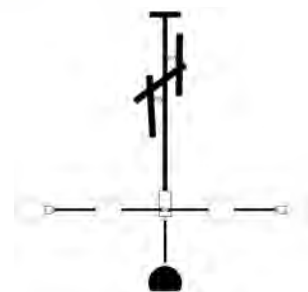
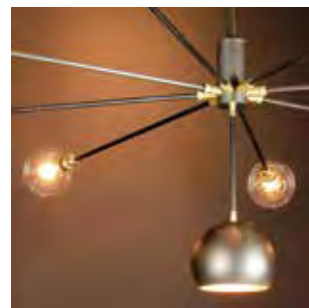

Ø1400xH1500



| Corpo/Body | Riflettore/Reflector | Particolari/Details |
|--|---|---|
| <ul style="list-style-type: none"> Acidatura scura Dark etched Acidatura chiara Light etched | <ul style="list-style-type: none"> Oro aranciato v. Orange gold p. Acidatura scura Dark etched Acidatura chiara Light etched | <ul style="list-style-type: none"> Ottone naturale Natural brass Ottone brunito Burnished brass |

Versioni/Versions

Terra/Floor
pag. 125

Parete-Soffitto
Wall-Ceiling
pag. 384
pag. 386
pag. 388

SOSPESE
PENDENT



Renzo Serafini
RENZO SERAFINI



STELLA ARTICOLATA

Ph. FTfoto
Project CierreEsse
Cannavacciuolo Cafè & Bistrot
Novara



STELLA ARTICOLATA

Ph. FTfoto
Project CierreEsse
Cannavacciuolo Cafè & Bistrot
Novara

OMBRELLO

10.031

Corpo in acciaio, vetri decorativi trasparenti Ø90 mm, driver integrato in struttura.
Steel structure, Ø90 mm transparent decorative glass, built-in driver.

CE IP20

| Voltage | Source | Watt | Lumen | CRI | Kelvin | Light beam |
|----------|------------|------|---------|-----|--------|------------|
| 220-240V | Modulo led | 7x1W | 7x125Lm | >80 | 2700K | wide |



1500x1100xH1250



| Corpo/Body | Riflettore/Reflector | Particolari/Details |
|--|----------------------|---|
| <ul style="list-style-type: none"> Acidatura scura <i>Dark etched</i> Acidatura chiara <i>Light etched</i> | - | <ul style="list-style-type: none"> Ottone naturale <i>Natural brass</i> Ottone brunito <i>Burnished brass</i> |

SOSPESE
PENDENTE

Renzo Serafini
RENZO SERAFINI

NIUDA

10.009.3

Corpo e rosone
in acciaio, catena
brunita 500 mm,
lampadina esclusa.
*Steel structure and
canopy, 500 mm
burnished chain,
bulb not included.*

CE IP20

| Voltage | Source | Watt | Lumen | CRI | Kelvin | Light beam |
|----------|--------|---------|-------|-----|--------|------------|
| 220-240V | E27 | MAX 60W | - | - | - | - |



200x200xH530

| Corpo/Body | Riflettore/Reflector | Particolari/Details |
|--|----------------------|--|
| <div style="display: flex; align-items: center;"> <div style="width: 15px; height: 15px; background-color: black; margin-right: 5px;"></div> <div> <p>Ferro nero <i>Raw black iron</i></p> </div> </div> | - | <div style="display: flex; align-items: center;"> <div style="width: 15px; height: 15px; background-color: black; margin-right: 5px;"></div> <div> <p>Ferro nero <i>Raw black iron</i></p> </div> </div> |

Versioni/Versions

Terra/Floor
pag. 122

Parete-Soffitto
Wall-Ceiling
pag. 372
pag. 390

SOSPESE PENDENT



Renzo Serafini
RENZO SERAFINI

ANTENNA

10.023

Corpo in acciaio,
lampadine escluse.
*Steel structure,
bulbs not included.*

CE IP20

| Voltage | Source | Watt | Lumen | CRI | Kelvin | Light beam |
|----------|--------|----------|-------|-----|--------|------------|
| 220-240V | E27 | MAX 100W | - | - | - | - |

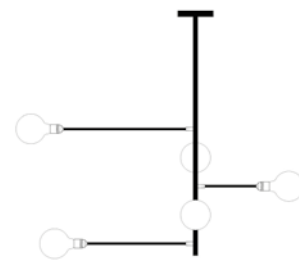

1785x1085xH1000

| Corpo/Body | Riflettore/Reflector | Particolari/Details |
|--|----------------------|---|
| <ul style="list-style-type: none"> Acidatura scura <i>Dark etched</i> Acidatura chiara <i>Light etched</i> | - | <ul style="list-style-type: none"> Ottone naturale <i>Natural brass</i> Ottone brunito <i>Burnished brass</i> |

SOSPESE
PENDENT

Versioni/Versions

Terra/Floor
pag. 124

Parete-Soffitto
Wall-Ceiling
pag. 384
pag. 386
pag. 388
pag. 400
pag. 402





ANTENNA

Ph. Stefano Borghesi
Relais San Vigilio



ANTENNA

Ph. FTfoto
Project CierreEsse
Clotilde Bistrot
Milano

IDEA SOSPESA

10.025

Corpo in acciaio,
lampadine escluse.
Steel structure, bulbs
not included.

CE IP20

| Voltage | Source | Watt | Lumen | CRI | Kelvin | Light beam |
|----------|--------|----------|-------|-----|--------|------------|
| 220-240V | E27 | MAX 100W | - | - | - | - |

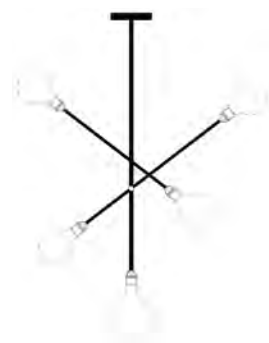

760x150xH1060

| Corpo/Body | Riflettore/Reflector | Particolari/Details |
|---|----------------------|--|
| <p>■ Acidatura scura Dark etched</p> <p>■ Acidatura chiara Light etched</p> | - | <p>■ Ottone naturale Natural brass</p> <p>■ Ottone brunito Burnished brass</p> |

Versioni/Versions

Terra/Floor
pag. 124

Parete-Soffitto
Wall-Ceiling
pag. 384
pag. 386
pag. 388
pag. 400
pag. 402



SOSPESE
PENDENT



Renzo Serafini
RENZO SERAFINI

STELLA

10.015

Corpo e rosone
in acciaio, catena
brunita 500 mm,
lampadine incluse.

Steel structure and
canopy, 500 mm burnished
chain, bulbs included.

CE IP20

| Voltage | Source | Watt | Lumen | CRI | Kelvin | Light beam |
|----------|----------|--------|---------|-----|--------|------------|
| 220-240V | E27 dimm | 8x5,5W | 8x500Lm | >90 | 2500K | wide |



Ø1300xH375



| Corpo/Body | Riflettore/Reflector | Particolari/Details |
|--|----------------------|---|
| <ul style="list-style-type: none"> Acidatura scura Dark etched Acidatura chiara Light etched | - | <ul style="list-style-type: none"> Ottone naturale Natural brass Ottone brunito Burnished brass |

SOSPESE
PENDENT

Versioni/Versions

Terra/Floor
pag. 124

Parete-Soffitto
Wall-Ceiling
pag. 384
pag. 386
pag. 388
pag. 400
pag. 402

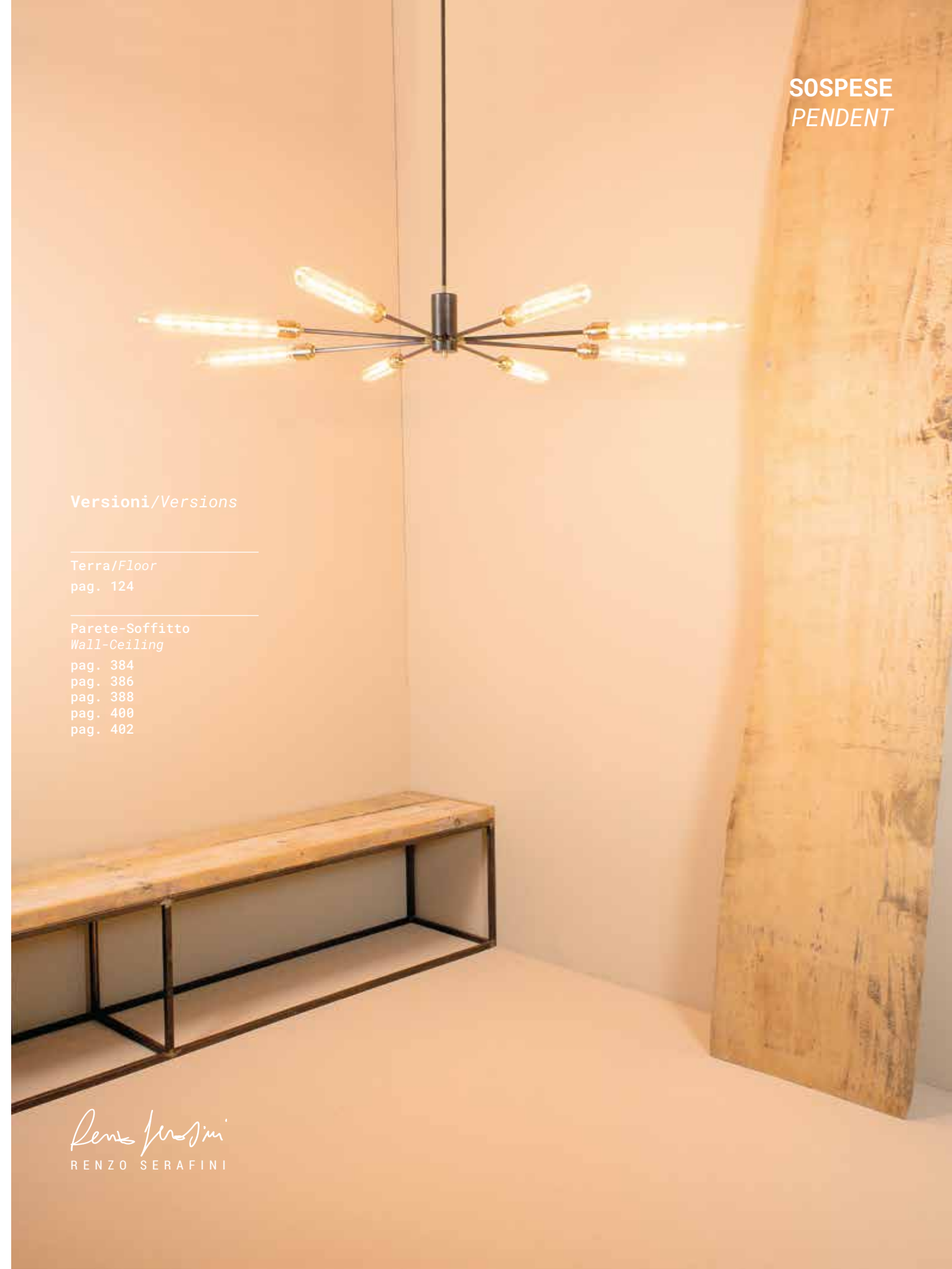

Renzo Serafini
RENZO SERAFINI

VERDE LUCE

10.041.160

Corpo in acciaio, ciotola e cilindro piccolo in alluminio, driver integrato in struttura.

Steel structure, aluminium bowl and small cylinder, built-in driver.

CE IP20

| Voltage | Source | Watt | Lumen | CRI | Kelvin | Light beam |
|----------|------------|------|-------|-----|--------|------------|
| 220-240V | Modulo led | 3W | 350Lm | >90 | 2700K | narrow |



10.041.300



| Corpo/Body | Riflettore/Reflector | Particolari/Details |
|---|----------------------|---|
| <ul style="list-style-type: none"> Oro antico Ancient gold Nero opaco v. Matte black p. | - | <ul style="list-style-type: none"> Ottone naturale Natural brass Ottone brunito Burnished brass |

SOSPESE
PENDENT



Renzo Serafini
RENZO SERAFINI



VERDE LUCE

Project Cristina Zanni
For Odeon Design Studio
San Marco Hotel



Project:

Paola Mariotto
Lucia Papa



Ai piedi dell'Etna

*Piove Luce, qui
/ aspra / lunare / elettrica / intima /
/ tremula / viva / liquida /*

Luce che si muove libera, che non conosce confini.
Filo conduttore, filo che unisce, percorso che indica la strada.
Il suo nome è Sistema Maniglia: Luce a cui aggrapparsi.

Sistema Maniglia è un prodotto modulabile e componibile a seconda delle esigenze e degli ambienti da illuminare, che nasce dalla necessità di portare luce nello spazio avendo soltanto un punto di alimentazione.

Con Sistema Maniglia la Luce arriva esattamente dove vuoi,
per costruire un dialogo con l'ambiente e farlo diventare
lui stesso un complemento d'arredo, semplice, lineare, vivo.

SISTEMA MANIGLIA

MANIGLIA SYSTEM

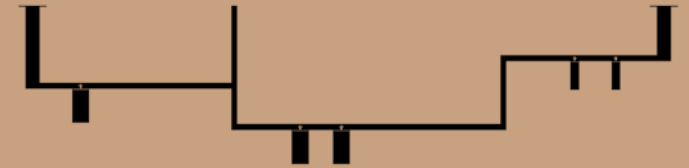

Light that moves freely, that knows no boundaries.

A common thread, a thread that unites, a path that shows the way.
Its name is Maniglia System: Light is like a handle to hold on to.

Maniglia System is a modular product and it is sectional according to the needs and environments that have to be illuminated. It was created from the necessity to bring light into spaces by having only one power supply point.

With the Maniglia System we bring light exactly where you want.
We are to the point of building a dialogue with the space, to make it in itself a simple, linear, living piece of furniture.

POSSIBILI ELEMENTI DELLA STRUTTURA

Su richiesta realizzazione della struttura con finiture materiche speciali.
We are able to create structures made up of tactile and material finishes upon request.

ATTACCO PUNTO LUCE CON PIASTRA CABLE ENTRY COMPONENT WITH PLATE

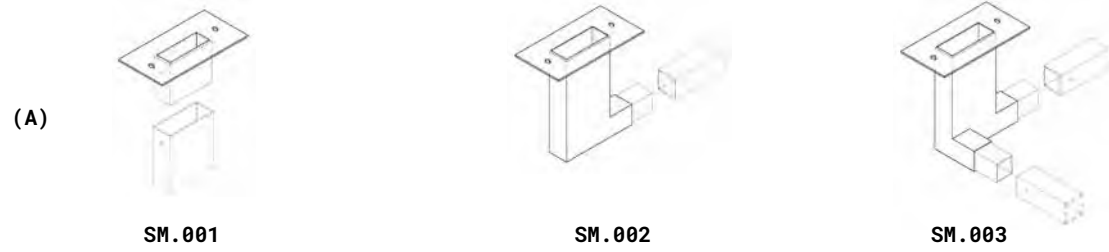

ATTACCO PUNTO LUCE CON BASE CABLE ENTRY COMPONENT WITH BASE

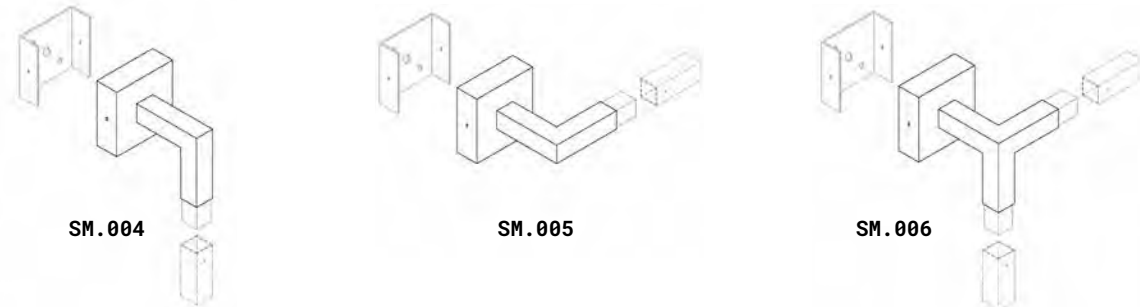

SUPPORTO PARETE/SOFFITTO WALL/CEILING SUPPORT

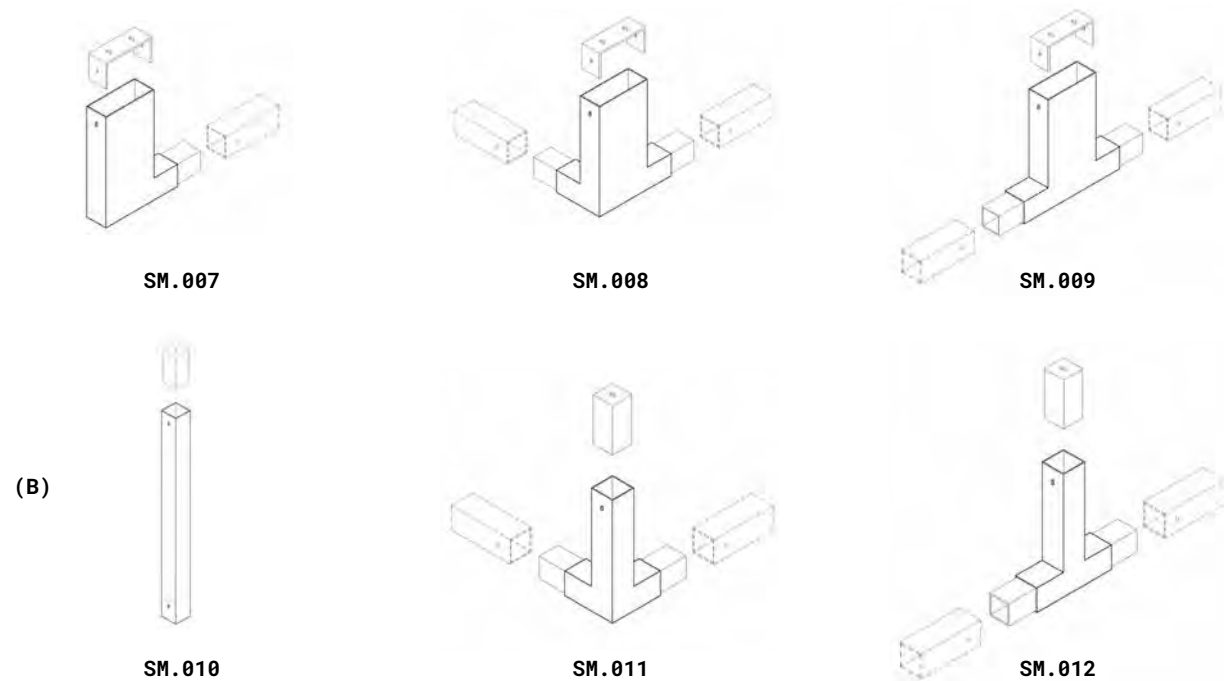

POSSIBLE ELEMENTS OF THE STRUCTURE

ELEMENTI LUCE LINEARE LINEAR LIGHT COMPONENTS

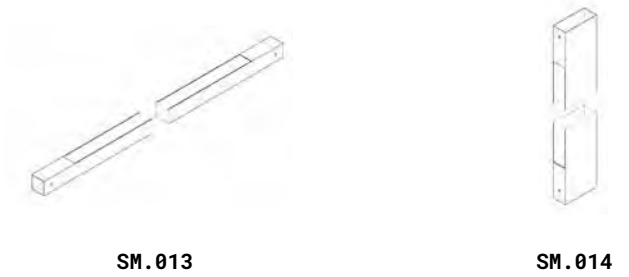

COMPONENTI STRUTTURA COMPONENTS OF THE STRUCTURE

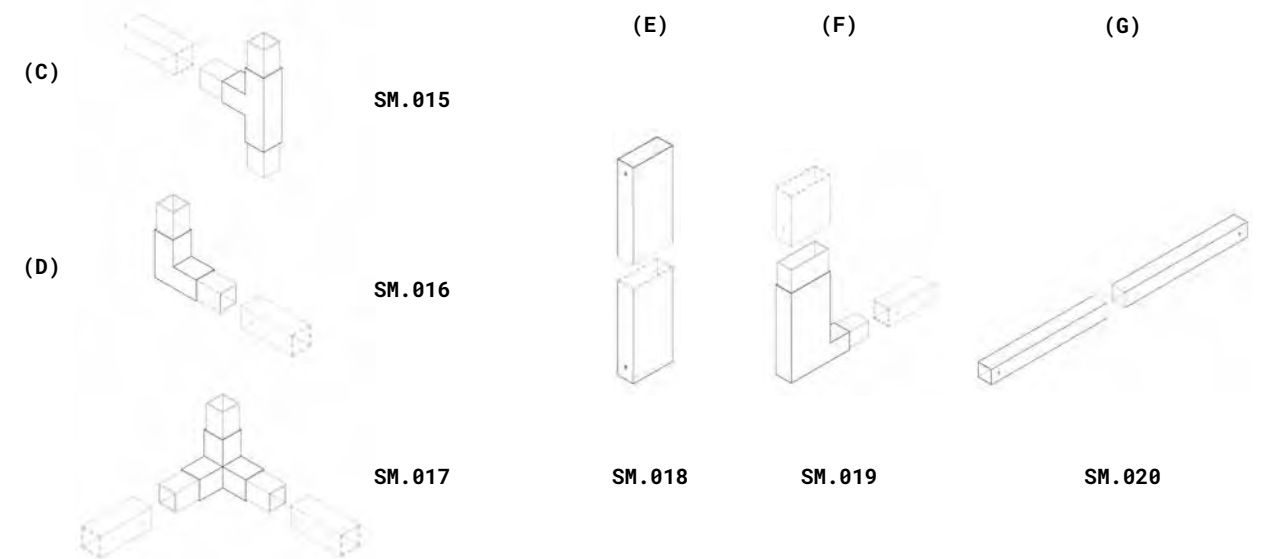

ESEMPIO EXAMPLE

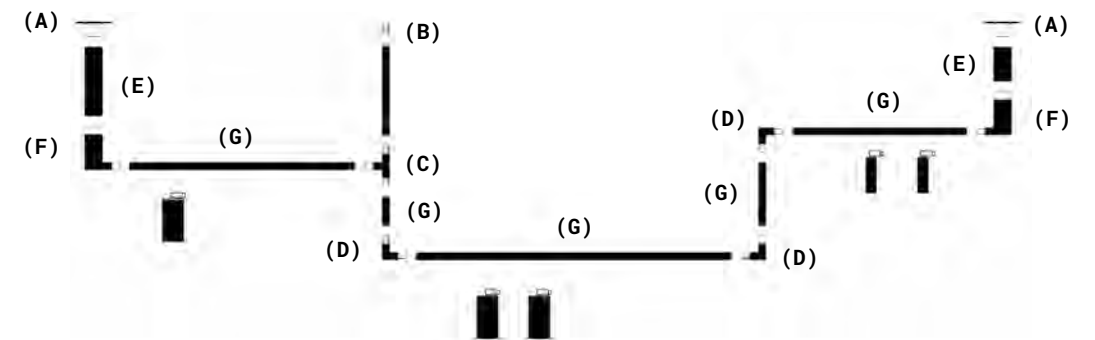

CORPI ILLUMINANTI LIGHTING FIXTURES

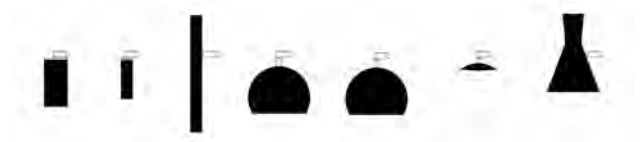



Sistema Maniglia
Project CENERE.studio
Private residence

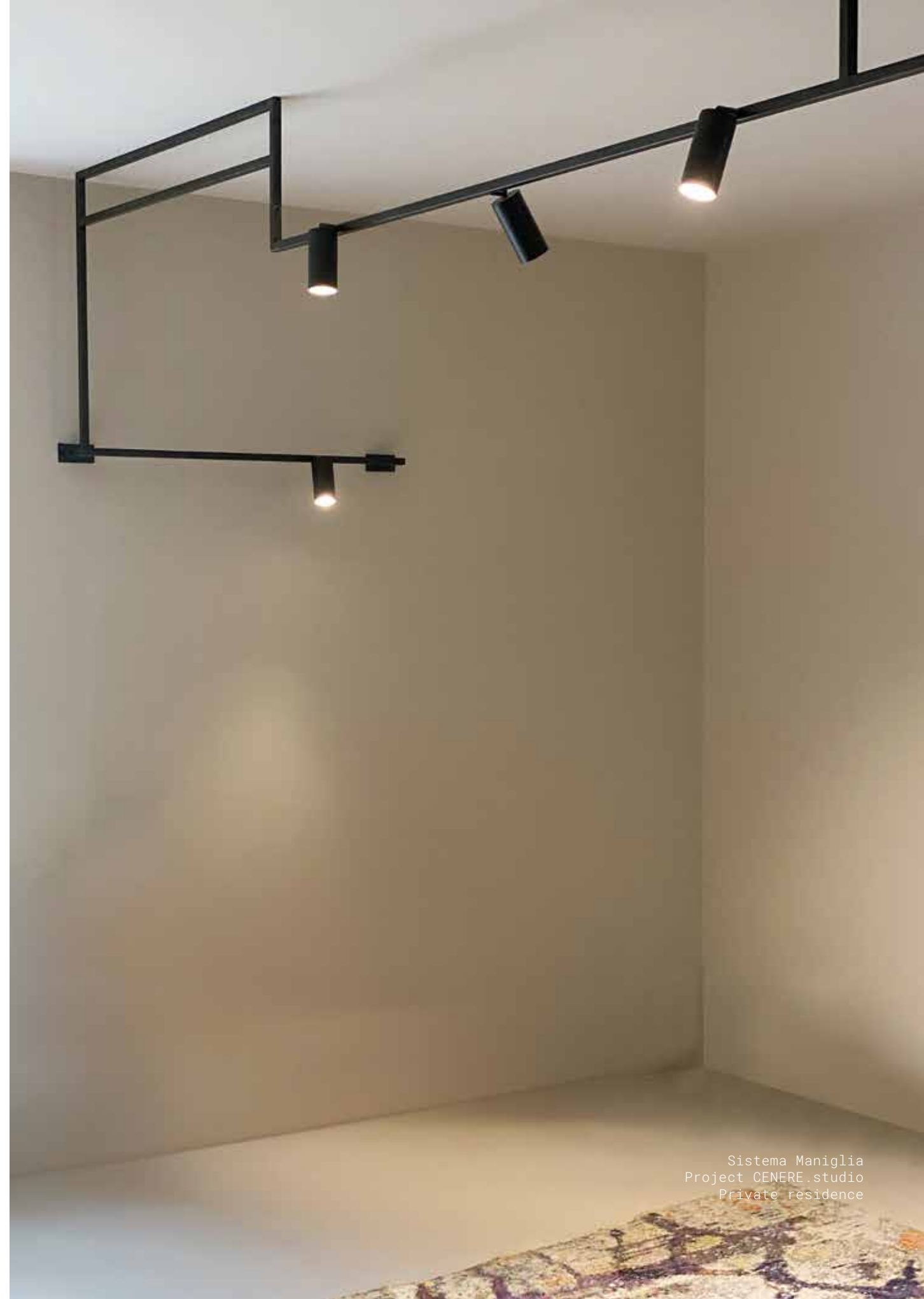

Sistema Maniglia
Project CENERE.studio
Private residence



Dimora
delle Balze
Sicilia

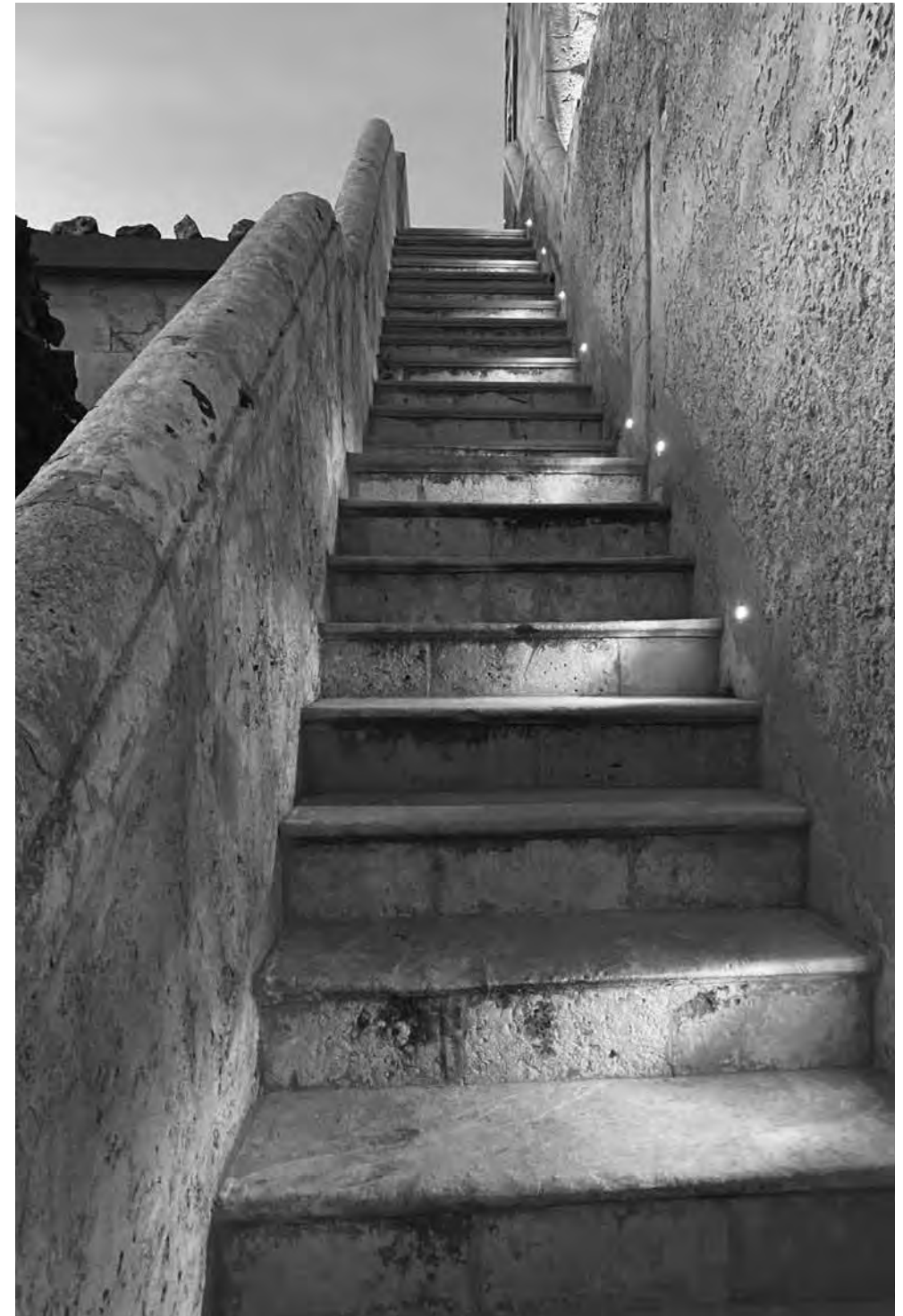

Alla Luce creiamo la casa, le di-segnamo la pelle.

Ottone, rame, vetro, acciaio.

I materiali che scegliamo per i nostri prodotti non sono semplicemente materia prima ma protagonisti principali all'interno del progetto. Sottoposti a un processo di lavorazione completamente artigianale, diventano elementi d'arredo che cambiano a seconda del trattamento ricevuto.

La nostra forza risiede nel mantenere e valorizzare le diverse personalità di queste finiture, trasformando prodotti funzionali, in prodotti funzionali di design. L'intersezione tra bello e utile, tra industria e artigianato.

FINITURE

FINISHES

Around the Light we have created its home, we de-sign her skin.

Brass, copper, glass, steel.

The materials that we choose for our products are not just raw materials, they are the principal elements which make up the project. Upon undergoing a completely handmade manufacturing process, they become furnishing elements that change depending on the treatment that they have received.

Our strength lies in maintaining and enhancing the different personalities of these finishes. We transform typical functional products into beautiful functional design pieces. An intersection is formed between beauty and practicality and between industry and craftsmanship.

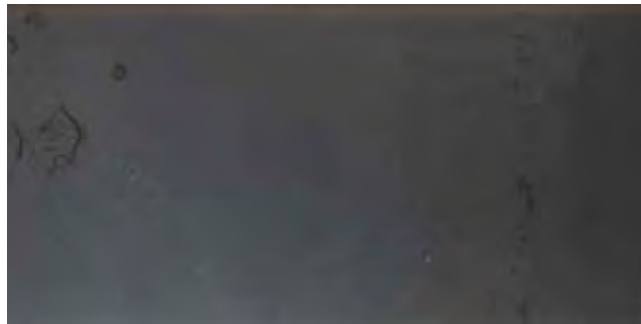

Ferro nero - Raw black iron .3

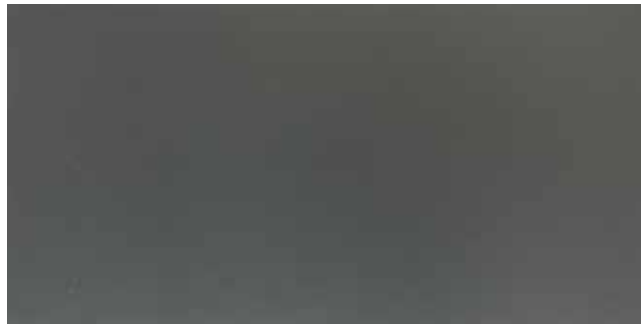

Verniciatura ferro - Iron paint .7



Verniciatura ottone brunito - Burnished brass painting .0B

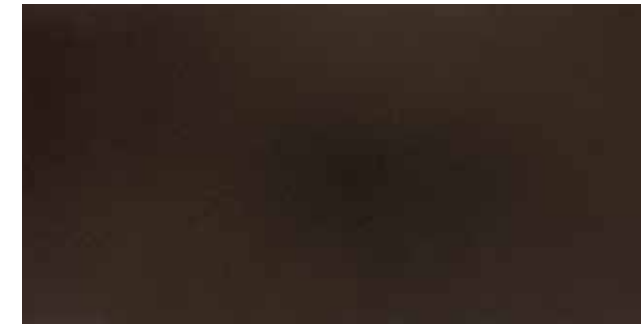

Verniciatura brunito - Burnished painting .4



Corten - Corten .6

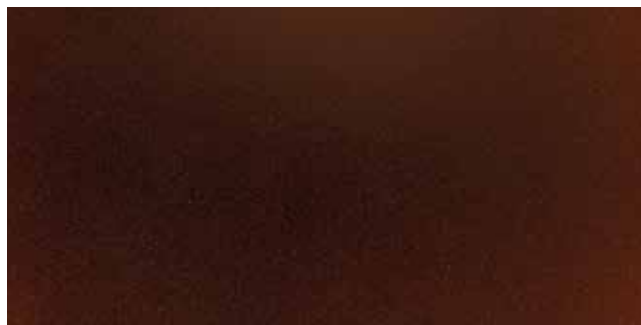

Verniciatura corten - Corten painting .9



Verniciatura bronzo - Bronze painting .12



Verniciatura rame brunito - Burnished copper painting .5

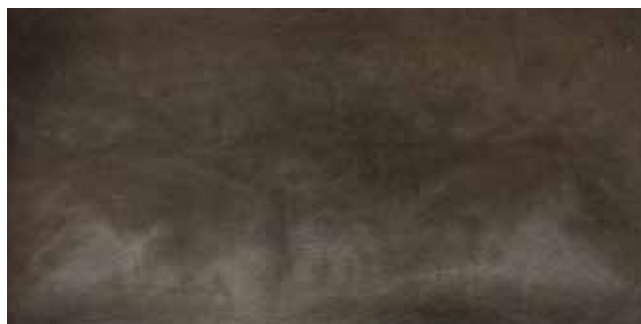

Acidatura chiara - Light etched .AC



Acidatura scura - Dark etched .AS



Acidatura oro antico - Antique gold etched .11



Verniciatura oro aranciato - Orange gold painting .10



Ottone naturale - Natural brass .ON



Ottone brunito - Burnished brass .ONB



Verniciatura crema - Cream painting .8



Alluminio spazzolato - Brushed aluminium .13



Ottone spazzolato - Brushed brass .ONS



Verniciatura ottone satinato - Satin brass painting .0S



Verniciatura nero opaco - Matte black painting .2



Verniciatura bianco opaco - Matte white painting .1



LIVINGSPEACEUK.COM

+44(0) 203 410 2977

FULHAM

53-55 FULHAM HIGH STREET
LONDON, SW6 3JJ

+44(0) 207 731 1180

ISLINGTON

36 CROSS STREET
LONDON, N1 2BG

+44(0) 207 359 3950

LIVINGSPACE
& PARTNERS