

# GLASS\_HINGED DOOR

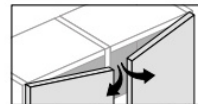

## FRONTS

- mirror
- bronzo mirror
- grigio mirror
- back-lacquered shiny glass
- back-lacquered satin glass

## TECHNICAL SPECIFICATIONS

The Glass hinged door consists of:

- a panel in low formaldehyde content wood particles 21mm-7/8" thickness with coloured glass or glued mirror 4mm-1/8" thickness with aluminium profiles.

**N.B.: INNER SIDE OF THE DOOR IN THE SAME FINISH AS THE STRUCTURE**

## VERTICAL PROFILE DETAIL

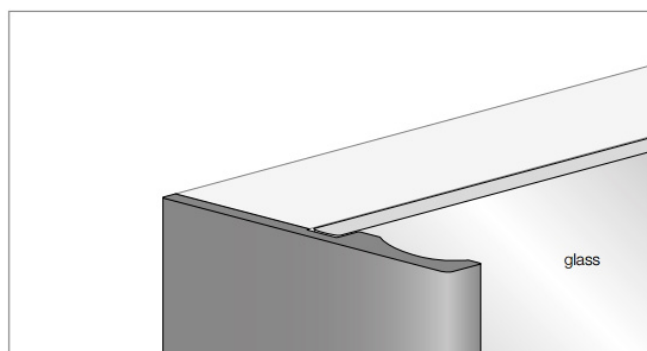

## PROFILES

- matt lacquered
- metal standard

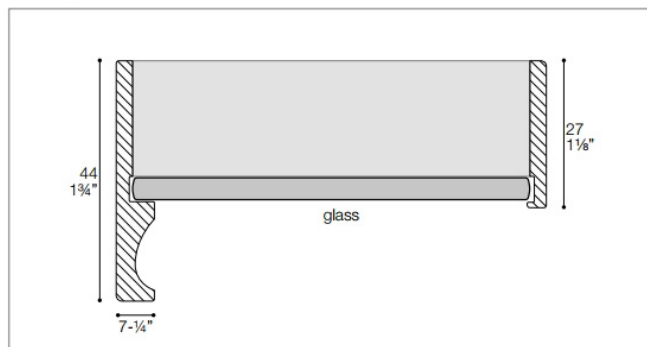

## DOOR SIZES

	H. 2384-93 <sup>5</sup> / <sub>8</sub> "	H. 2544-100 <sup>1</sup> / <sub>2</sub> "	H. 2896-114"
W. 450-17 <sup>3</sup> / <sub>4</sub> "	•	•	-
W. 500-19 <sup>5</sup> / <sub>8</sub> "	•	•	-
W. 600-23 <sup>5</sup> / <sub>8</sub> "	•	•	-

## BUILT-IN HANDLE IN THE FULL-HEIGHT PROFILE

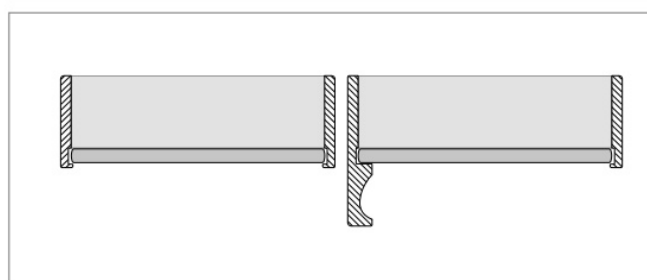

In the case of pairs of hinged doors it is not recommended to use the handle on both doors

- = AVAILABLE
- = NOT AVAILABLE

**CUSTOM PROCESSINGS ARE NOT POSSIBLE**

# HINGED DOOR WARDROBE

## DIMENSIONAL CHARACTERISTICS

### HEIGHT

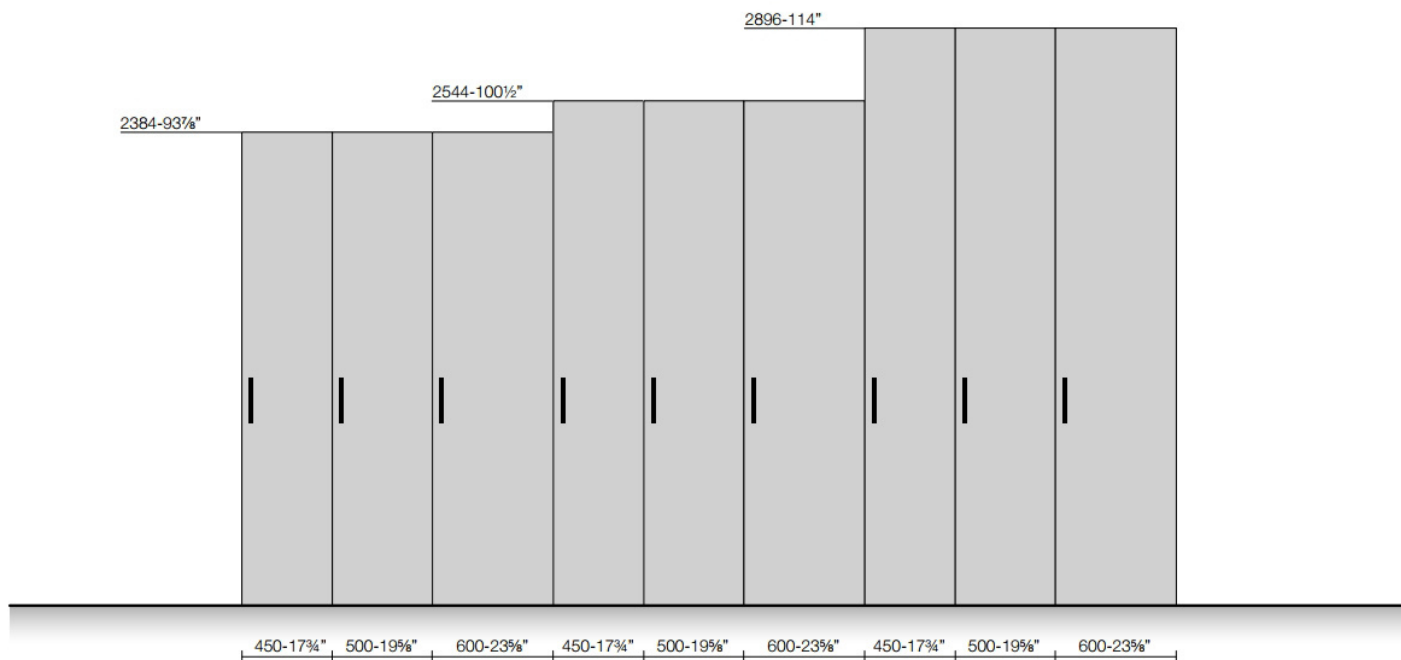

### STRUCTURE WIDTH AND DEPTH (EXCLUDING DOOR)

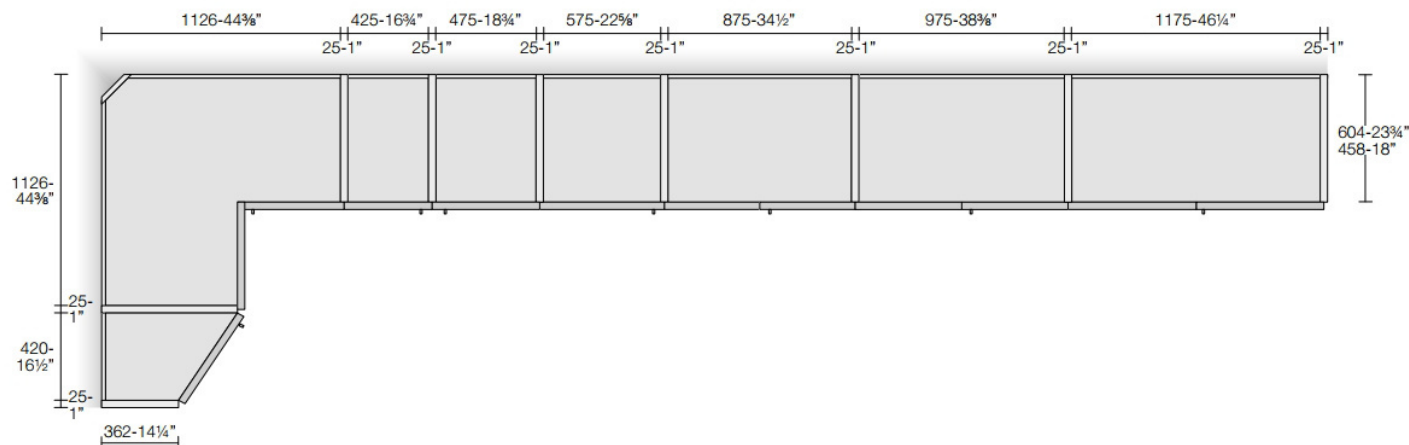

- All wardrobes are supplied with a base made of metal profiles and adjustable feet that ensure, besides quick assembly, excellent and durable stability as well as perfect door closure. The framework is supplied in a single piece the same length as the wardrobe up to a maximum length of 4.975 mm.
- The removable bottom panel allows easy cleaning and can be used as a secret compartment; it is not available in compartments with drawer packs, interior partitions and in wardrobes with coplanar sliding doors.
- **The price of the modules always includes a structural shelf and two standard clothes hanger rails.**
- **The price of the module with side depth reduced to 458-18" mm, is equal to the price of the module with standard depth.**
- **The price of the modules also includes the plinth.**

# HINGED DOOR WARDROBE

## SIDE

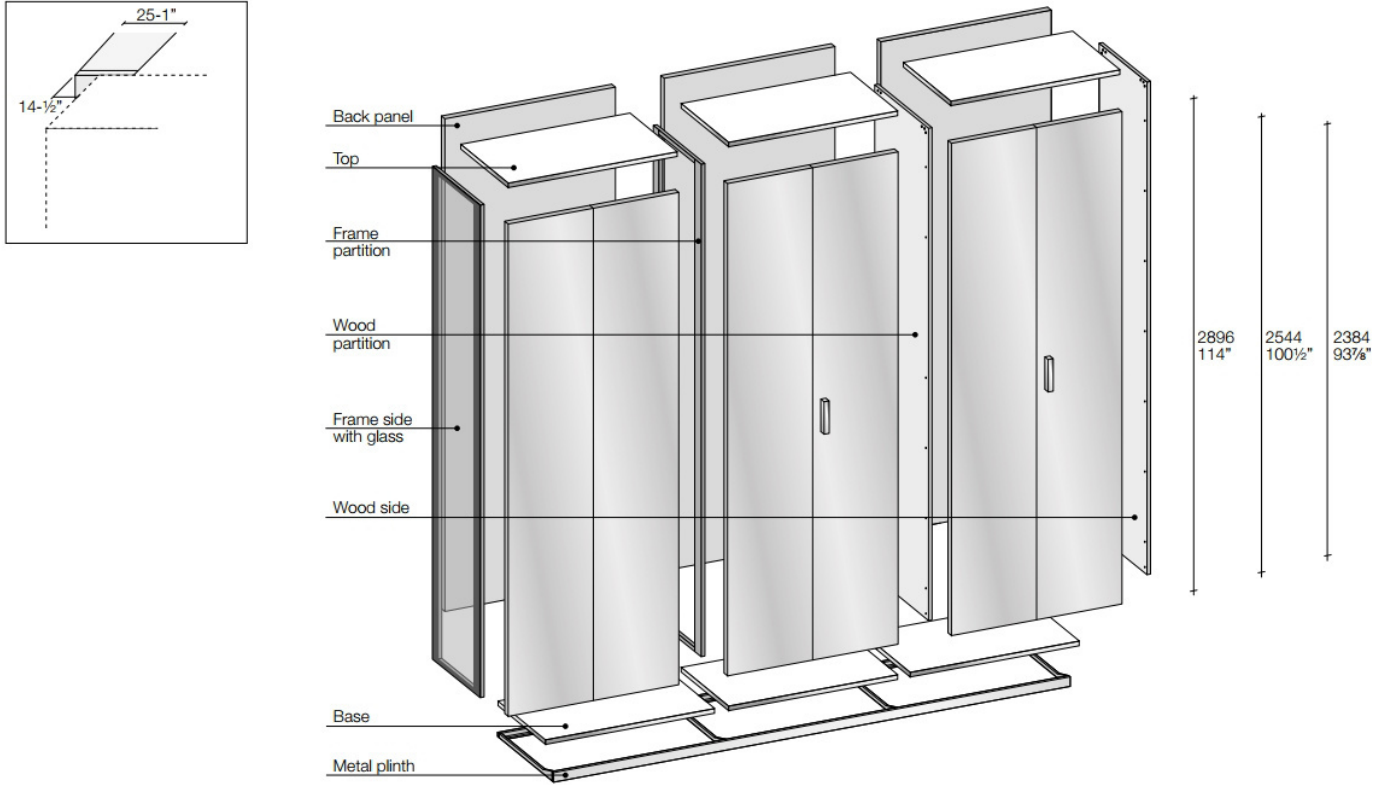

Constant holes at 64-2½" mm pitch (standard)

Holes only on the shelves. The positioning of the shelves will always follow the reference hole at a pitch of 64-2½" mm (on request)

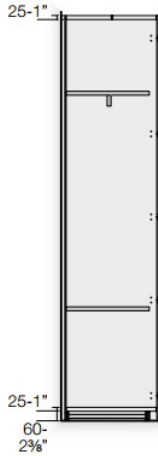
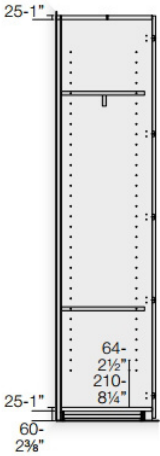

The holes only on the shelves will be supplied on request and at the same price and a drawing with the necessary dimensions must be provided by you, always following the reference holes at a pitch of 64-2½" mm.

## ASSEMBLY CHARACTERISTICS

To assemble the wardrobe, a space of 30-1⅞" mm in width is required for all the opening systems.

A space of 25-1" mm in height is required to assemble the hinged wardrobe.

To assemble the sliding and coplanar wardrobe, this height space is required:

**+ 40mm / 1⅝"**  
for assembly of the doors

**+ 70mm / 2¾"**  
for easy adjustment

Space occupied by the mechanisms of the sliding and coplanar wardrobe in height for the external assembly and subsequent insertion in the recess:

**+ 30mm / 1⅞"**

our wardrobes  
have been  
made to rest  
on three solid  
foundational ideas:

stability  
adjustability  
reliability



The aluminium base not only allows quick and simple assembly, but also facilitates any disassembly operations for any time you might move house.

# WARDROBES PROGRAM PRESENTATION



Adjustment and levelling foot with a capacity of 100-3 $\frac{3}{8}$ " kg. The adjustment is transmitted along the entire length of the frame in order to avoid imbalances typical of traditional wardrobes with wooden base. The possible adjustment is from 0 to 12mm- $\frac{1}{2}$ "1.

The entire wardrobe distributes the weight uniformly on the structure, ensuring stability over time.



The aluminium profile has a section with differentiated sealing and reinforced points absorb the various pressures of the system.



The removable base allows facilitates cleaning and can also be used as a secret compartment.

## CLEAR OR SATIN GLASS

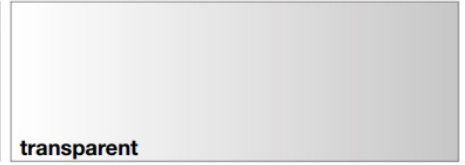

## MIRRORS

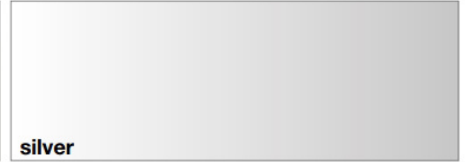

### CONFORMITY TO SAMPLE

Conformity to sample cannot be considered as absolute since there are tolerance margins due to product variations (colours, materials, sizes) or caused by environmental factors (light, humidity, etc.).

If orders are completed at different moments in time we cannot guarantee the exact likeness of colours and/or finishes between the first original layout and the additional elements.

**N.B.: The reproduction of colours on paper may differ slightly from the original ones.**