

DESIGN RENZO SERAFINI

GHIANDA

10.026



IP20



lampada sospesa in ottone spazzolato con vetro decorativo trasparente, lampadina LED inclusa, cavo in tessuto

pendant lamp / brushed brass, transparent decorative glass, LED bulb included, fabric cord

ATTACCO • LAMP HOLDER

G9

tensione di alimentazione • supply voltage 230V

SORGENTE LUMINOSA • LIGHT SOURCE

potenza • power 5 W

lumen • lumen 450 Lm

temperatura colore • colour temperature 3000K

***lampadina LED inclusa • *LED bulb included**

CARATTERISTICHE FISICHE • PHYSICAL CHARACTERISTICS

materiale • material
ottone, tessuto / brass, fabric

finitura • finish
ottone spazzolato, cavo nero / brushed brass, black cable

materiale diffusore • diffuser material
vetro / glass

Classe Energetica / Energy Label F



GHIANDA

istruzioni di montaggio • assembly instructions

[disattivare l'alimentazione di rete prima di iniziare l'installazione]

[switch off the mains supply before starting the installation]

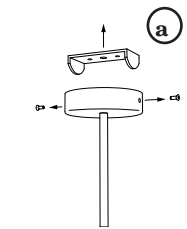

- 1 **svitare le viti e fissare a soffitto la base 'a'**
undo the screws and fix the base 'a' to the ceiling

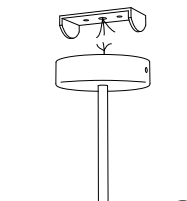

- 2 **Eseguire il cablaggio con alimentazione 230V.**
Collegare cavo giallo/verde di messa a terra
Do the wiring with 230V.
Connect the yellow/green ground wire

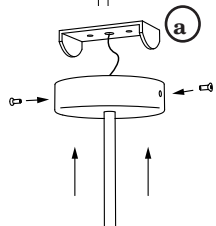

- 3 **Fissare la struttura alla base 'a'.**
Fix the structure to the base 'a'.



- 4 **Alimentare con 230V**
Power with 230V

DESIGN RENZO SERAFINI

GHIANDA 4X

10.026.4X



IP20



lampada sospesa in ottone naturale, vetri decorativi satinati, lampadine LED incluse, particolari in ottone o ferro

pendant lamp / natural brass, satin decorative glass, LED bulbs included, brass or iron details

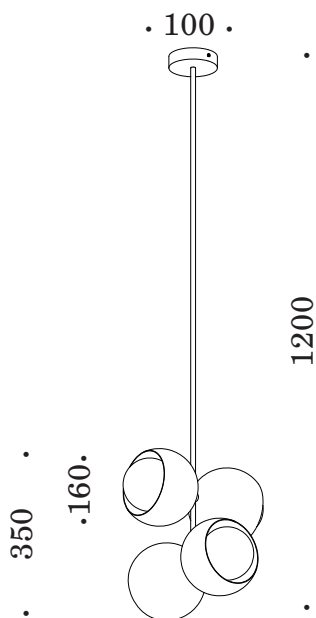

ATTACCO • LAMP HOLDER

E27

tensione di alimentazione • supply voltage 230V

SORGENTE LUMINOSA • LIGHT SOURCE

potenza • power 5W
lumen • lumen 470 Lm
temperatura colore • colour temperature 2700 K

***lampadina LED inclusa • *LED bulb included**

CARATTERISTICHE FISICHE • PHYSICAL CHARACTERISTICS

materiale • material
 ottone / brass

finitura • finish
 ottone naturale / natural brass

materiale diffusore • diffuser material
 vetro / glass

finitura diffusore • diffuser finish
 satinato / satin

Classe Energetica / Energy Label F

GHIANDA 4X

istruzioni di montaggio • assembly instructions

[disattivare l'alimentazione di rete prima di iniziare l'installazione]

[switch off the mains supply before starting the installation]

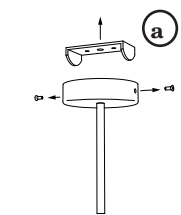

- 1 **svitare le viti e fissare a soffitto la base 'a'**
undo the screws and fix the base 'a' to the ceiling

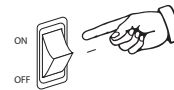

- 5 **Alimentare con 230V**
Power with 230V

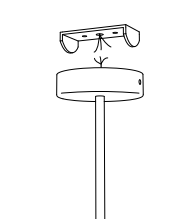

- 2 **Eseguire il cablaggio con alimentazione 230V.**
Collegare cavo giallo/verde di messa a terra
Do the wiring with 230V.
Connect the yellow/green ground wire

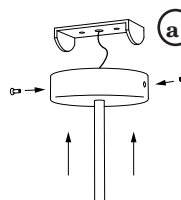

- 3 **Fissare la struttura alla base 'a'.**
Fix the structure to the base 'a'.

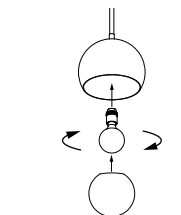

- 4 **Avvitare le lampadine in dotazione e i vetri decorativi**
Screw the supplied bulbs and decorative glasses

GHIANDA 8X

10.026.8X



IP20



lampada sospesa in ottone naturale, vetri decorativi satinati, lampadine LED incluse, particolari in ottone

pendant lamp / natural brass, satin decorative glasses, LED bulbs included, brass or iron details

ATTACCO • LAMP HOLDER

 E27 DIM.

tensione di alimentazione • supply voltage 230V

SORGENTE LUMINOSA • LIGHT SOURCE

potenza • power 5 W

lumen • lumen 470 Lm

temperatura colore • colour temperature 2700 K

***lampadina LED inclusa • *LED bulb included**

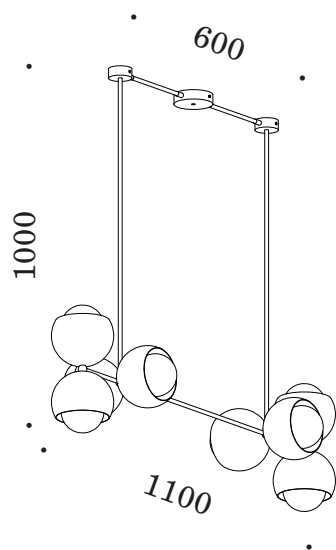

CARATTERISTICHE FISICHE • PHYSICAL CHARACTERISTICS

materiale • material
ottone

finitura • finish
ottone naturale / natural brass

materiale diffusore • diffuser material
vetro / glass

finitura diffusore • diffuser finish
satinato / satin

Classe Energetica / Energy Label F

GHIANDA 8X

istruzioni di montaggio • assembly instructions

[disattivare l'alimentazione di rete prima di iniziare l'installazione]

[switch off the mains supply before starting the installation]

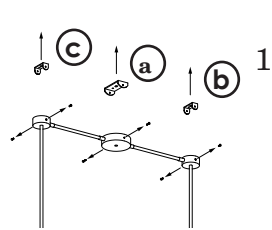

1

svitare le viti e fissare a soffitto le basi 'a', 'b', 'c'
undo the screws and fix the bases 'a', 'b', 'c' to the ceiling

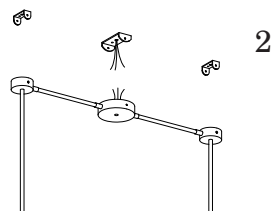

2

Eseguire il cablaggio con alimentazione 230V.
Collegare cavo giallo/verde di messa a terra
Do the wiring with 230V.
Connect the yellow/green ground wire

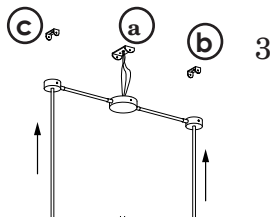

3

Fissare la struttura alle basi 'a', 'b', 'c'.
Fix the structure to the bases 'a', 'b', 'c'.

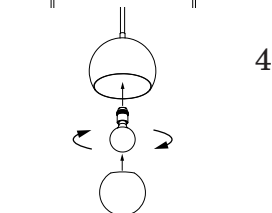

4

Avvitare le lampadine in dotazione e i vetri decorativi
Screw the supplied bulbs and decorative glasses

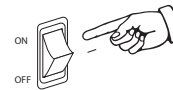

5

Alimentare con 230V
Power with 230V