

SAND SOFA

Struttura in legno
Wooden frame

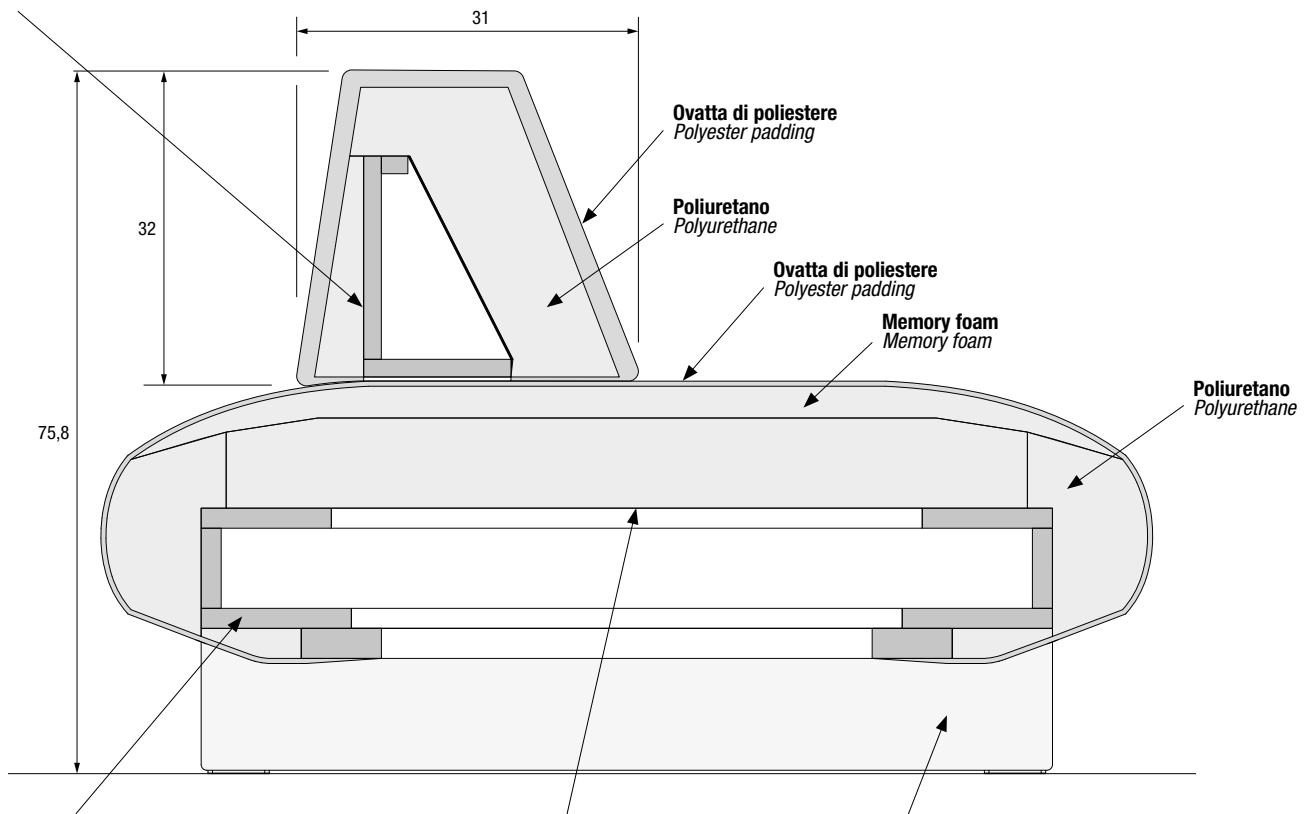

Struttura in legno
Wooden frame

Cinghie elastiche
Elastic belts

Gambe in acciaio verniciato
Painted steel legs

COMPATIBILITÀ//COMPATIBILITY

Basi per schienali self-standing
Base units for self-standing backrests

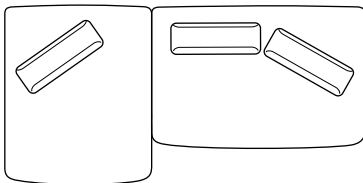

Divano lineare + base self-standing
Linear sofa + self-standing base unit

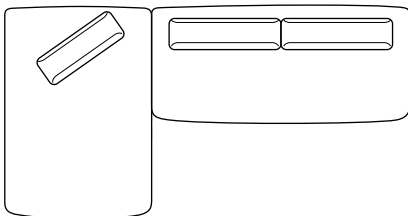

Divano lineare + chaise longue
Linear sofa + chaise longue

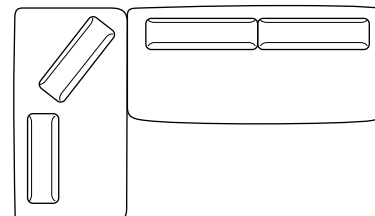

Le basi e le penisole laterali possono solo essere combinate fra loro.
The base units and side chaise units can only be combined together.

Base laterale + penisola laterale
Side base unit + side chaise unit

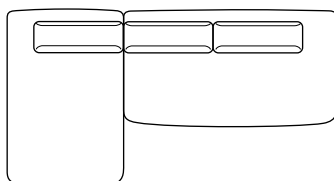

Base laterale + base self-standing
Side base unit + self-standing base unit

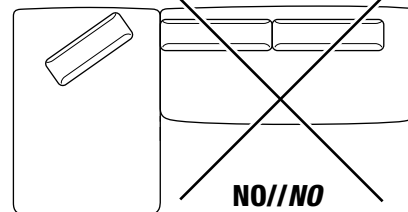

SAND SOFA - BASI PER SCHIENALI SELF-STANDING//BASE UNITS FOR SELF-STANDING BACKRESTS

Categorie
Categories

A: Tessuto cliente.
A: Customer's fabric.

B: Darwin. Please.
B: Darwin. Please.

C: Francis, Axum, Barkley, Frosty, Penny, Barnum.
C: Francis, Axum, Barkley, Frosty, Penny, Barnum.

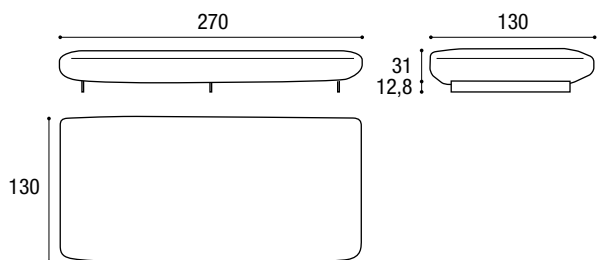
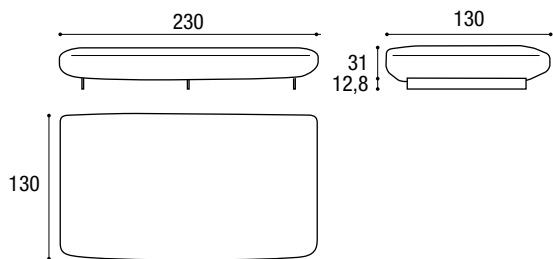
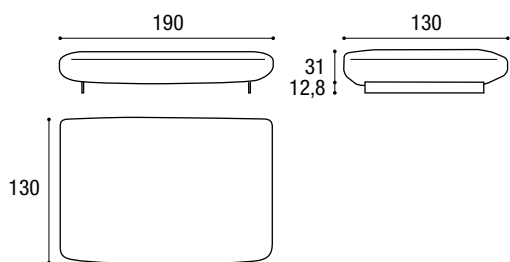
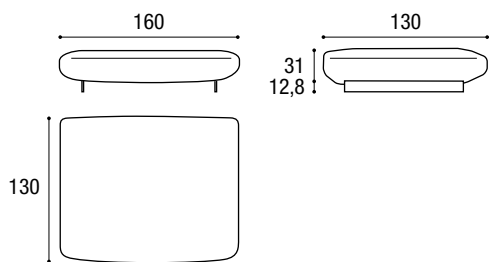
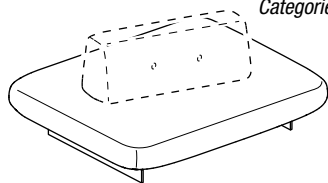

Gambe in acciaio Peltro steel o Titanio steel.
Steel supports in Peltro Steel or Titanio Steel.

		Codice Code	A	B	C	m
L/W	P//D					
160	130	NB0002				4,90
190	130	NB0003				5,20
230	130	NB0004				5,60
270	130	NB0005				6,30

SAND SOFA - PENISOLE PER SCHIENALI SELF-STANDING//CHAISE SOFA FOR SELF-STANDING BACKRESTS

Categorie
Categories

A: Tessuto cliente.
A: Customer's fabric.

B: Darwin. Please.
B: Darwin. Please.

C: Francis, Axum, Barkley, Frosty, Penny, Barnum.
C: Francis, Axum, Barkley, Frosty, Penny, Barnum.

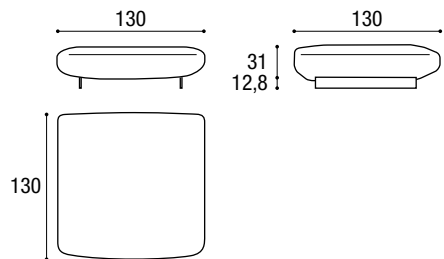
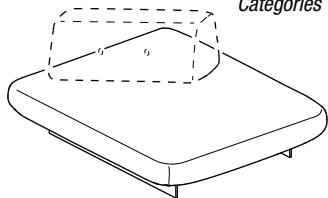

Gambe in acciaio Peltro steel o Titanio steel.
Steel supports in Peltro Steel or Titanio Steel.

		Codice Code	A	B	C	m
L/W	P//D					
130	130	NB0006				4,60
130	160	NB0007				4,90

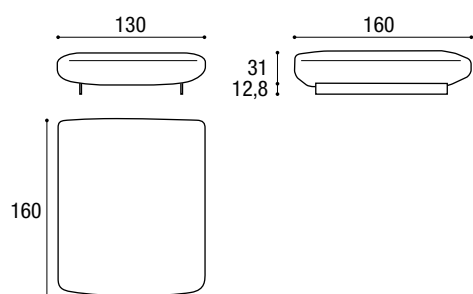

SAND SOFA - PENISOLE PER SCHIENALI SELF-STANDING//CHAISE SOFA FOR SELF-STANDING BACKRESTS

Categorie
Categories

A: Tessuto cliente.
A: Customer's fabric.

B: Darwin. Please.
B: Darwin. Please.

C: Francis. Axum. Barkley. Frosty. Penny. Barnum.
C: Francis. Axum. Barkley. Frosty. Penny. Barnum.

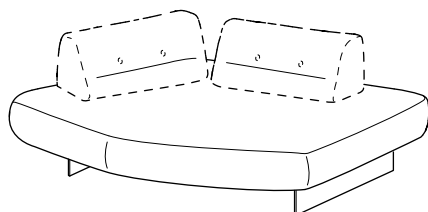

Sinistra//Left

Destra//Right



Gambe in acciaio Peltro steel o Titanio steel.
Steel supports in Peltro Steel or Titanio Steel.

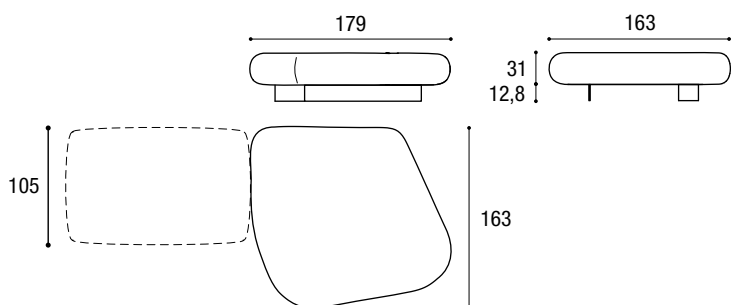

		Codice Code	A	B	C	m
L/W	P//D					
179	163	NB0008				4,80
190	187	NB0009				5,70

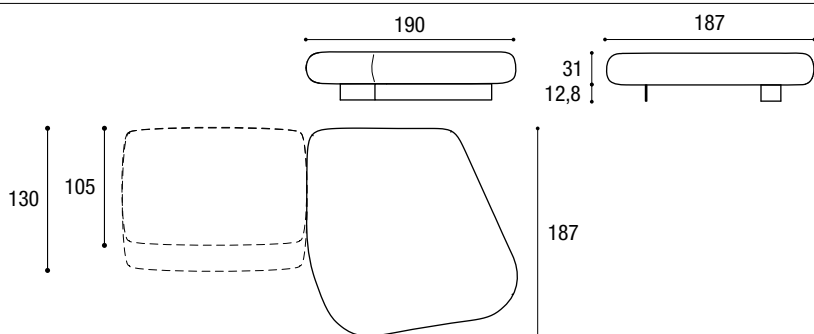

Non disponibile nella finitura pelle.
Leather not available.

SAND SOFA - SCHIENALI SELF-STANDING//SELF-STANDING BACKRESTS

Categorie
Categories

A: Tessuto cliente.
A: Customer's fabric.

B: Darwin. Please.
B: Darwin. Please.

C: Francis, Axum, Barkley, Frosty, Penny, Barnum.
C: Francis, Axum, Barkley, Frosty, Penny, Barnum.

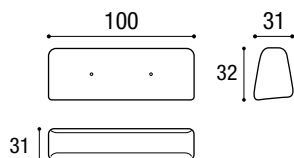
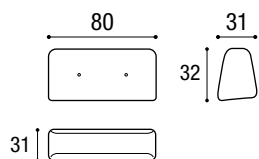
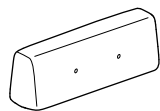

Gambe in acciaio Peltro steel o Titanio steel.
Steel supports in Peltro Steel or Titanio Steel.

	Codice Code	A	B	C	 m
L/W					
80	NC0001				1,20
100	NC0002				1,40

SAND SOFA - DIVANI LINEARI CON SCHIENALI FISSI//LINEAR SOFAS WITH FIXED BACKRESTS

Categorie **A:** Tessuto cliente.
Categories **A:** Customer's fabric.

B: Darwin. Please, Ecopelle Bloom.
B: Darwin. Please, Bloom Faux leather.

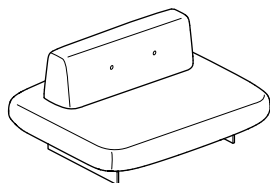

C: Francis, Axum, Barkley, Frosty, Penny, Barnum.
C: Francis, Axum, Barkley, Frosty, Penny, Barnum.

P: Pelle Panama.
P: Panama leather.

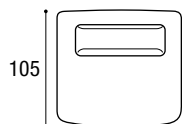
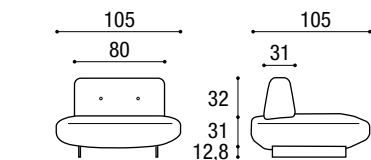

Gambe in acciaio Peltro steel o Titanio steel.
Steel supports in Peltro Steel or Titanio Steel.



		Codice Code	A	B	C	P	 m	 m²
L//W	P//D							
105	105	NA1001					5,3	8,1
130	105	NA1002					5,8	8,8
190	105	NA1003					7,4	11,2
230	105	NA1004					8,2	12,3
270	105	NA1005					9,5	15,8

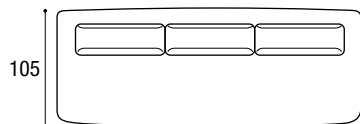
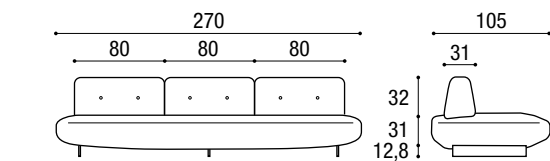
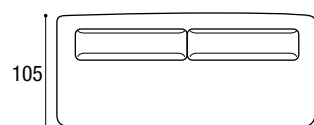
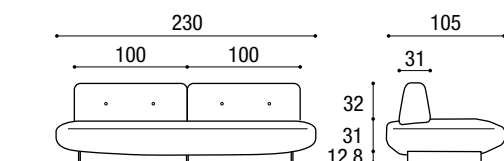
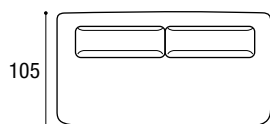
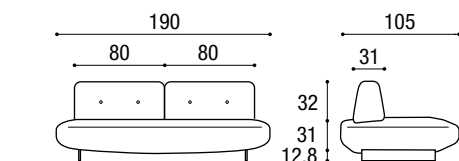
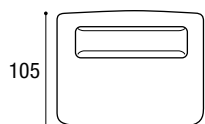
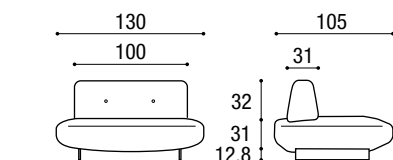

PELLE: basi L 105, 130 e 190 cm hanno una cucitura. Basi L 230 e 270 cm hanno due cuciture. 255
LEATHER: base units W. 105, 130 and 190 cm have one line of stitching. Base units W. 230 and 270 cm have two lines of stitching.

SAND SOFA - CHAISE LONGUE CON SCHIENALI FISSI DX O SX//CHAISE LONGUE WITH FIXED BACKRESTS LH OR RH

Categorie **A:** Tessuto cliente.
Categories **A:** Customer's fabric.

B: Darwin. Please, Ecopelle Bloom.
B: Darwin. Please, Bloom Faux leather.

C: Francis, Axum, Barkley, Frosty, Penny, Barnum.
C: Francis, Axum, Barkley, Frosty, Penny, Barnum.

P: Pelle Panama.
P: Panama leather.

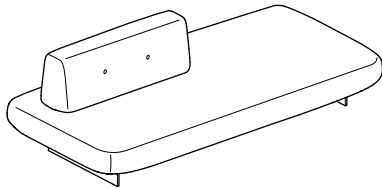

Disponibile versione destra o sinistra
Left-hand and right-hand versions available

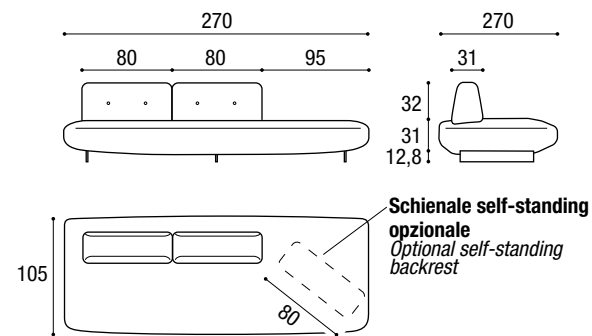
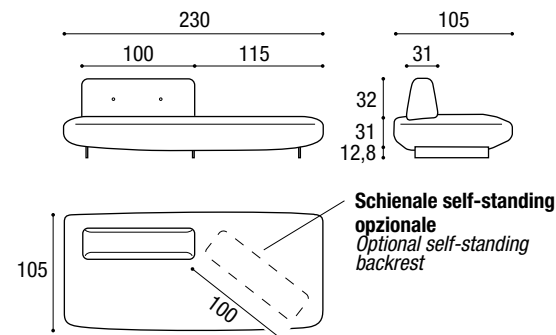
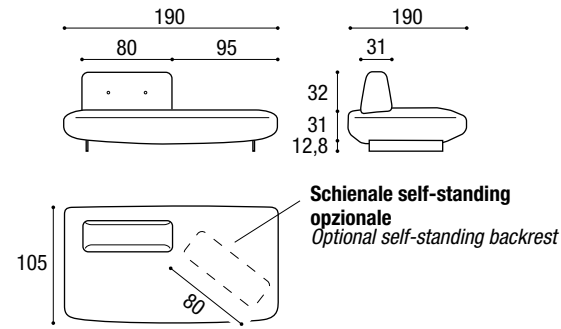

Gambe in acciaio Peltro steel o Titanio steel.
Steel supports in Peltro Steel or Titanio Steel.

L/W	P//D	Codice Code	A	B	C	P	Area	
							€ m	m ²
190	105	NA0010					6,2	9,6
230	105	NA0011					6,8	10,5
270	105	NA0012					8,3	14,2

In pelle non utilizzabile schienale self-standing.
For models in leather, self-standing backrests cannot be used.

SAND SOFA - BASI LATERALI DX-SX CON SCHIENALI FISSI//L/R SIDE BASE UNITS WITH FIXED BACKRESTS

Categorie **A:** Tessuto cliente.
Categories **A:** Customer's fabric.

B: Darwin. Please, Ecopelle Bloom.
B: Darwin. Please, Bloom Faux leather.

C: Francis, Axum, Barkley, Frosty, Penny, Barnum.
C: Francis, Axum, Barkley, Frosty, Penny, Barnum.

P: Pelle Panama.
P: Panama leather.

Destra//Right

Sinistra//Left

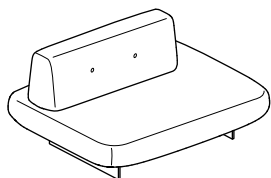

Gambe in acciaio Peltro steel o Titanio steel.
Steel supports in Peltro Steel or Titanio Steel.

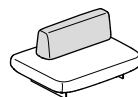
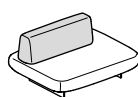

In tabella i disegni rappresentano penisole terminali destre.
The drawings in the table below show right-hand end chaise units.

		Codice Code	A	B	C	P	m	m ²	
L//W	P//D								
 	 	105	105	NA0001				4,1	6,50
 	 	130	105	NA0002				4,4	70
 	 	190	105	NA0003				5	80
 	 	230	105	NA0004				5,40	8,70
 	 	270	105	NA0005				5,90	110

PELLE: basi L 105, 130 e 190 cm hanno una cucitura. Basi L 230 e 270 cm hanno due cuciture.
LEATHER: base units W. 105, 130 and 190 cm have one line of stitching. Base units W. 230 and 270 cm have two lines of stitching.

SAND SOFA - PENISOLE LATERALI DX-SX CON SCHIENALI FISSI//L/R SIDE CHAISE UNITS WITH FIXED BACKRESTS

Categorie **A:** Tessuto cliente.
Categories **A:** Customer's fabric.

B: Darwin. Please, Ecopelle Bloom.
B: Darwin. Please, Bloom Faux leather.

C: Francis, Axum, Barkley, Frosty, Penny, Barnum.
C: Francis, Axum, Barkley, Frosty, Penny, Barnum.

P: Pelle Panama.
P: Panama leather.

Destra//Right

Sinistra//Left

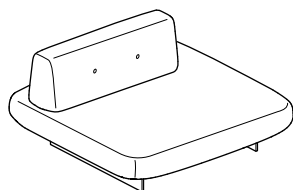

Gambe in acciaio Peltro steel o Titanio steel.
Steel supports in Peltro Steel or Titanio Steel.

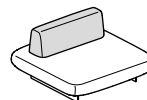
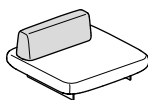

In tabella i disegni rappresentano penisole terminali destre.
The drawings in the table below show right-hand end chaise units.

		Codice Code	A	B	C	P	m	m ²
L//W	P//D							
		NA0006					4,4	70
		NA0007					4,60	7,50
		NA0008					4,70	7,50
		NA0009					4,90	8,50

SAND SOFA - POUFF O RACCORDO ANGOLARE//POUFFE OR CORNER PIECE

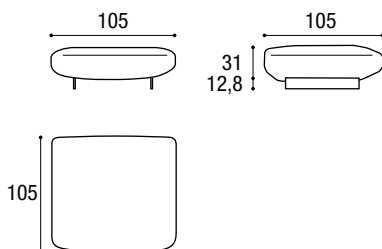
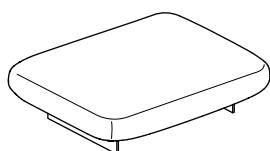

Gambe in acciaio Peltro steel o Titanio steel.
Steel supports in Peltro Steel or Titanio Steel.

Codice Code	A	B	C	P	m	m ²
NB0001					4,1	6,5





SAND SOFA - CUSCINI INTERNO FIBRA ANALLERGICA//CUSHIONS FILLED WITH HYPOALLERGENIC FIBRES

Categorie **A:** Tessuto cliente.
Categories **A:** Customer's fabric.

B: Darwin. Please, Ecopelle Bloom.
B: Darwin. Please, Bloom Faux leather.

C: Francis, Axum, Barkley, Frosty, Penny, Barnum.
C: Francis, Axum, Barkley, Frosty, Penny, Barnum.

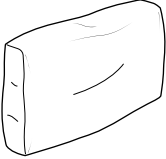
P: Pelle Panama.
P: Panama leather.

		Codice Code	A	B	C	P	 m	 m ²
L/W	H							
Cuscino con fascia <i>Cushion with panel</i>								
								
55,2	50,6	DI5185					0,70	10
73,6	50,6	DI5186					0,90	1,40
Cuscino a saponetta quadrata <i>Square soap-shaped cushion</i>								
								
36,8	36,8	DI5171					0,40	0,60
46	46	DI5172					0,50	0,80
Cuscino a saponetta lombare <i>Back-support soap-shaped cushion</i>								
								
55,2	32,2	DI5175					0,60	0,70

Imbottitura e tessuti ignifughi disponibili su richiesta.
Fire-resistant padding and fabrics available on request.





SAND SOFA - CUSCINI INTERNO PIUMA D'OCA//CUSHIONS FILLED WITH GOOSE FEATHERS

Categorie **A:** Tessuto cliente.
Categories **A:** Customer's fabric.

B: Darwin. Please, Ecopelle Bloom.
B: Darwin. Please, Bloom Faux leather.

C: Francis, Axum, Barkley, Frosty, Penny, Barnum.
C: Francis, Axum, Barkley, Frosty, Penny, Barnum.

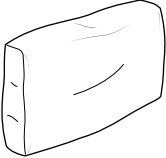
P: Pelle Panama.
P: Panama leather.

		Codice Code	A	B	C	P	 m	 m ²
L/W	H							
Cuscino con fascia <i>Cushion with panel</i>								
								
55,2	50,6	DI5085					0,70	10
73,6	50,6	DI5086					0,90	1,40
Cuscino a saponetta quadrata <i>Square soap-shaped cushion</i>								
								
36,8	36,8	DI5071					0,40	0,60
46	46	DI5072					0,50	0,80
Cuscino a saponetta lombare <i>Back-support soap-shaped cushion</i>								
								
55,2	32,2	DI5075					0,60	0,70

SAND SOFA - ESEMPI DI COMPOSIZIONI//COMPOSITION EXAMPLES

Categorie A: Tessuto cliente.
Categories A: Customer's fabric.

B: Darwin. Please, Ecopelle Bloom.
B: Darwin. Please, Bloom Faux leather.

C: Francis, Axum, Barkley, Frosty, Penny, Barnum.
C: Francis, Axum, Barkley, Frosty, Penny, Barnum.

P: Pelle Panama.
P: Panama leather.

TIPO SCHIENALE//TYPE OF BACKREST

ⓕ fisso//Fixed

Ⓢ self-standing//self-standing

1133*

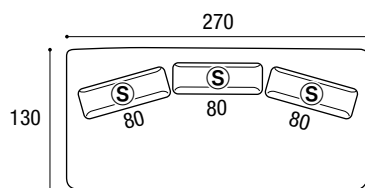

Composizione Composition	L//W	P//D	A//H	Codice Code	A	B**	C	P
1133	270	130	75,8	ND0003				-
Cuscino a saponetta quadrata//Square soap-shaped cushion n°2 (prezzo cad.//price each.)	36,8	12	36,8	DI5071				
Cuscino a saponetta lombare//Back-support soap-shaped cushion n°1 (prezzo cad.//price each.)	55,2	12	32,2	DI5075				

1135

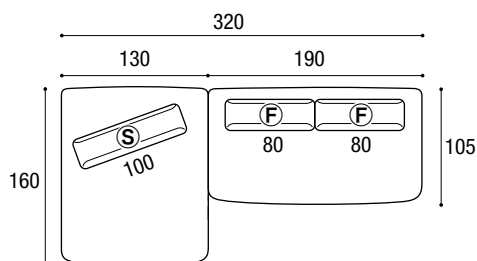

Composizione Composition	L//W	P//D	A//H	Codice Code	A	B**	C	P
1135	320	160	75,8	ND0005				-

1137*

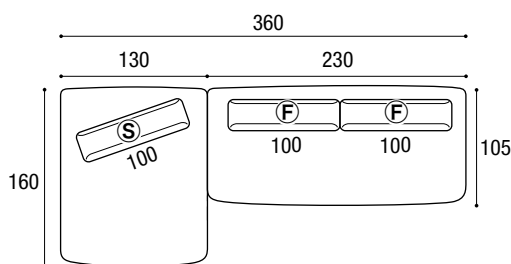

Composizione Composition	L//W	P//D	A//H	Codice Code	A	B	C	P
1137	360	160	78,5	ND0007				-

1136*

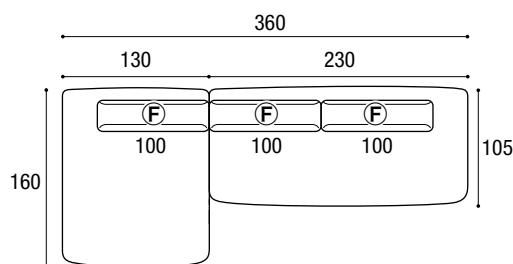

Composizione Composition	L//W	P//D	A//H	Codice Code	A	B	C	P
1136	360	160	78,5	ND0006				

SAND SOFA - ESEMPI DI COMPOSIZIONI//COMPOSITION EXAMPLES

Categorie **A:** Tessuto cliente.
Categories **A:** Customer's fabric.

B: Darwin. Please, Ecopelle Bloom.
B: Darwin. Please, Bloom Faux leather.

C: Francis, Axum, Barkley, Frosty, Penny, Barnum.
C: Francis, Axum, Barkley, Frosty, Penny, Barnum.

P: Pelle Panama.
P: Panama leather.

TIPO SCHIENALE//TYPE OF BACKREST

ⓕ fisso//Fixed

Ⓢ self-standing//self-standing

1141

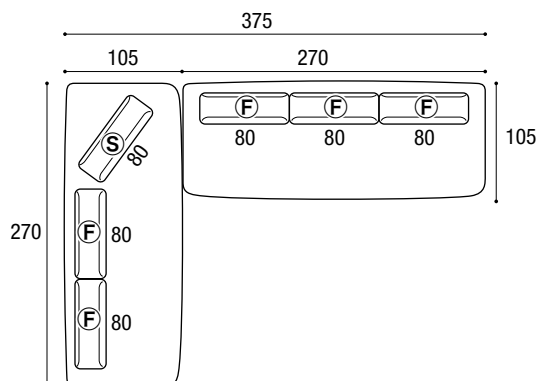

Composizione Composition	L//W	P//D	A//H	Codice Code	A	B**	C	P
1141	375	270	75,8	ND0011				-
Cuscino a saponetta quadrata//Square soap-shaped cushion	36,8	12	36,8	DI5071				
Cuscino a saponetta lombare//Back-support soap-shaped cushion	55,2	12	32,2	DI5075				

1144

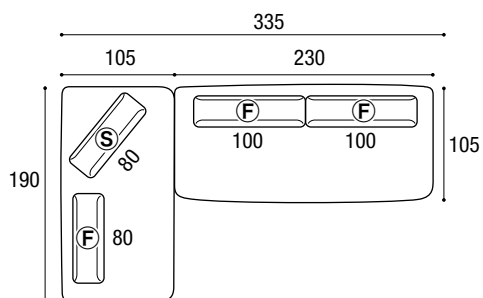

Composizione Composition	L//W	P//D	A//H	Codice Code	A	B**	C	P
1144	335	190	75,8	ND0014				-
Cuscino a saponetta quadrata//Square soap-shaped cushion n°2 (prezzo cad./price each.)	46	12	46	DI5072				

1146

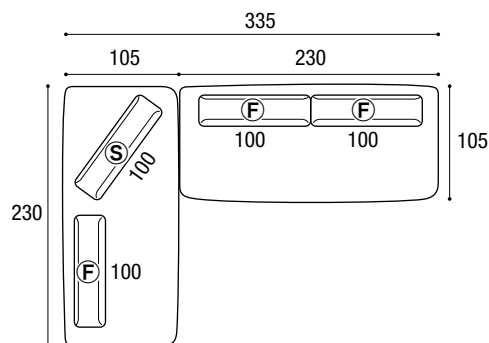

Composizione Composition	L//W	P//D	A//H	Codice Code	A	B**	C	P
1146	335	230	75,8	ND0016				-

1148

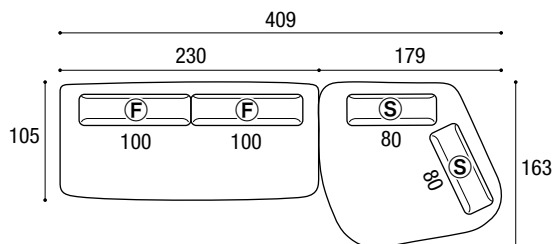

Composizione Composition	L//W	P//D	A//H	Codice Code	A	B	C	P
1148	409	163	75,8	ND0079				-

** Ecopelle non disponibile
** Faux leather not available

* Composizione a catalogo
* Catalogue composition

SAND SOFA - ESEMPI DI COMPOSIZIONI//COMPOSITION EXAMPLES

Categorie
Categories

A: Tessuto cliente.
A: Customer's fabric.

B: Darwin. Please, Ecopelle Bloom.
B: Darwin. Please, Bloom Faux leather.

C: Francis, Axum, Barkley, Frosty, Penny, Barnum.
C: Francis, Axum, Barkley, Frosty, Penny, Barnum.

P: Pelle Panama.
P: Panama leather.

TIPO SCHIENALE//TYPE OF BACKREST

Ⓕ fisso//Fixed

Ⓖ self-standing//self-standing

1153*

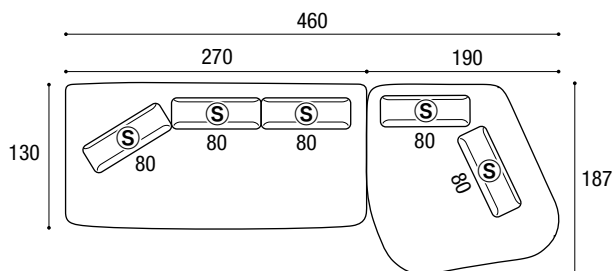

Composizione Composition	L//W	P//D	A//H	Codice Code	A	B	C	P
1153	460	187	75,8	ND0084				-
Cuscino a saponetta quadrata//Square soap-shaped cushion	46	12	46	DI5072				
Cuscino a saponetta quadrata//Square soap-shaped cushion	36,8	12	36,8	DI5071				
Cuscino a saponetta lombare//Back-support soap-shaped cushion n°2 (prezzo cad.//price each.)	55,2	12	32,2	DI5075				

2702*

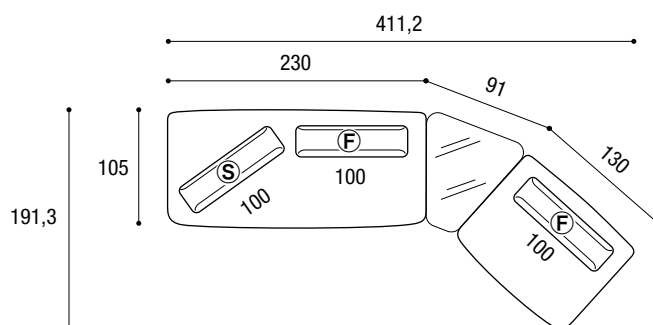

Composizione Composition	L//W	P//D	A//H	Codice Code	A	B	C	P
2702	411,2	191,3	75,8	270201				
Cuscino a saponetta quadrata//Square soap-shaped cushion	36,8	12	36,8	DI5071				

2704*

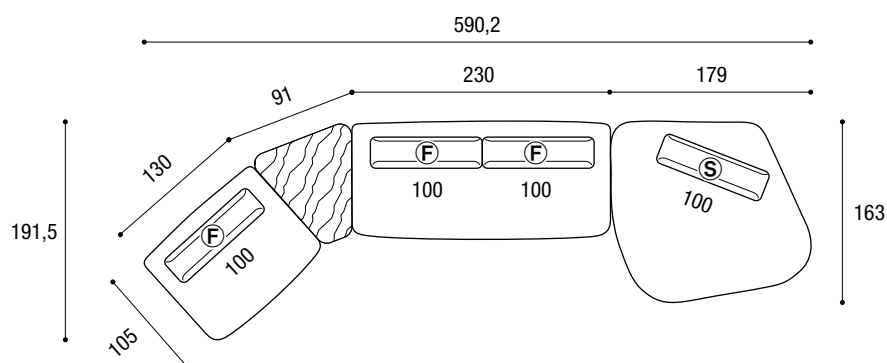

Composizione Composition	L//W	P//D	A//H	Codice Code	A	B	C	P
2704	590,2	191,5	75,8	270401				
Cuscino a saponetta lombare//Back-support soap-shaped cushion n°2 (prezzo cad.//price each.)	55,2	12	32,2	DI5075				

RICAMBIO RIVESTIMENTO BASI DIVANO SAND//REPLACEMENT COVER FOR SAND SOFA BASES

Larghezza Width	Profondità Depth	Codice Code	Ricambio A Change A	Ricambio B* Change B*	Ricambio C Change C	Ricambio P** Change P**
105	105	NR2001				
130	105	NR2002				
190	105	NR2003				
230	105	NR2004				
270	105	NR2005				

RICAMBIO RIVESTIMENTO PENISOLE DIVANO SAND//REPLACEMENT COVER FOR SAND CHAISE SOFAS

Larghezza Width	Profondità Depth	Codice Code	Ricambio A Change A	Ricambio B Change B	Ricambio C Change C	Ricambio P** Change P**
105	130	NR3001				
	160	NR3003				
130	130	NR3002				
	160	NR3004				

RICAMBIO RIVESTIMENTO BASI POUFF DIVANO SAND//REPLACEMENT COVER FOR SAND SOFA POUFFE BASES

Larghezza Width	Profondità Depth	Codice Code	Ricambio A Change A	Ricambio B Change B	Ricambio C Change C	Ricambio P Change P
105	105	NR4001				
130	130	NR4002				
160	130	NR4003				
190	130	NR4004				
230	130	NR4005				
270	130	NR4006				
130	160	NR4007				

RICAMBIO RIVESTIMENTO SCHIENALI FISSI DIVANO SAND//REPLACEMENT COVER FOR SAND SOFA FIXED BACKRESTS

Larghezza Width	Profondità Depth	Codice Code	Ricambio A Change A	Ricambio B Change B	Ricambio C Change C	Ricambio P Change P
80	31	NR0001				
100	31	NR0002				

**RICAMBIO RIVESTIMENTO SCHIENALI SELF-STANDING DIVANO SAND
REPLACEMENT COVER FOR SAND SOFA SELF - STANDING BACKRESTS**

Larghezza Width	Profondità Depth	Codice Code	Ricambio A Change A	Ricambio B* Change B*	Ricambio C Change C
80	31	NR1001			
100	31	NR1002			

RICAMBIO TESSUTO CUSCINI//FABRIC CHANGE FOR CUSHIONS

Larghezza Width	Profondità Depth	Codice Code	Ricambio A Change A	Ricambio B Change B	Ricambio C Change C	Ricambio P Change P
36,8	36,8	D25071				
46	46	D25072				
55,2	32,2	D25075				
	50,6	D25085				
73,6	50,6	D25086				

** Non disponibile per basi e penisole con schienali Self-standing
 ** Not available for base units or side chaise units with self-standing backrests

* Ecopelle non disponibile
 * Faux leather not available