

Esempi componibilità doghe testata
Wall panels headboard composition

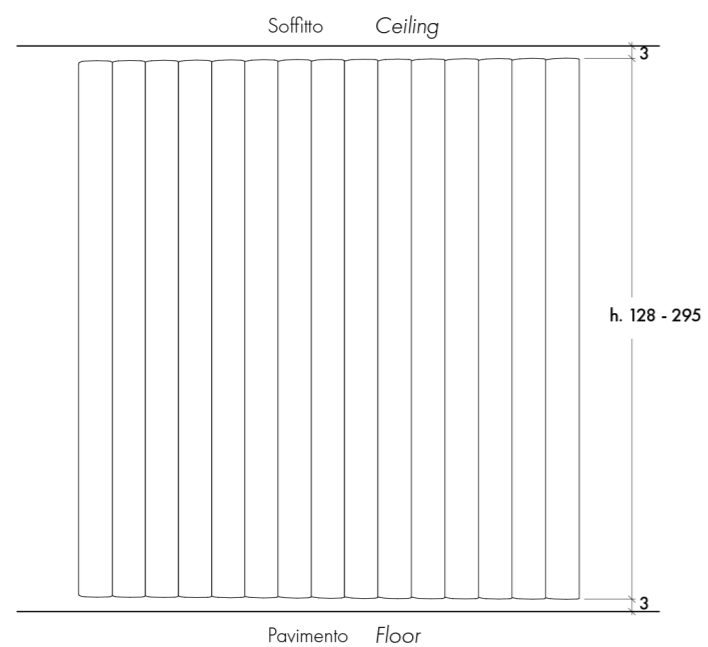

Singola doga
Wall panels unit

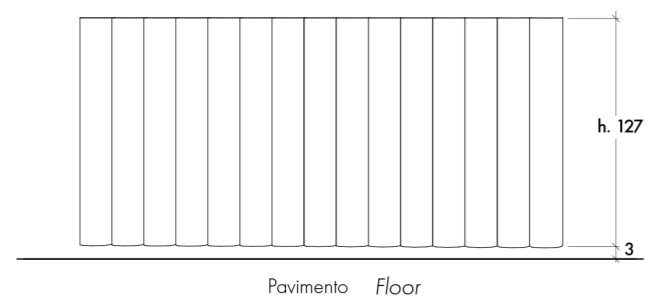
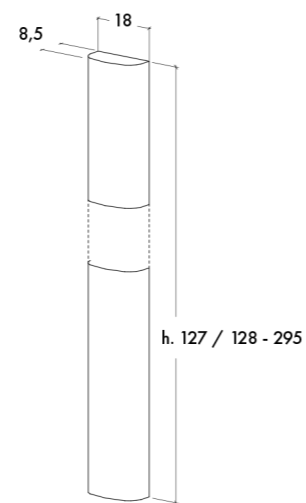

Testata a muro
Bed headboard on wall

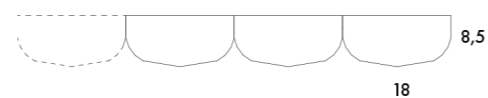

Testata con struttura
Bed headboard with structure

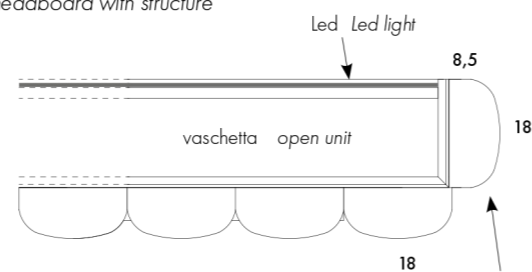

Doga laterale
Lateral wall
panels unit

Struttura interna testata con nicchia senza doghe
Internal structure for headboard with box without vertical panels

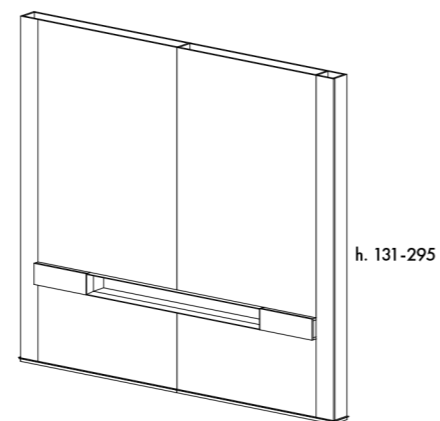
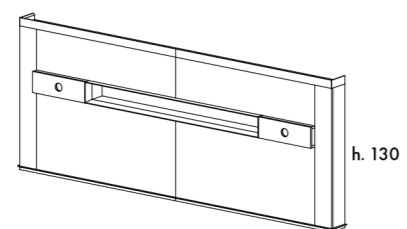

Letto DRESS CODE: testata a muro
DRESS CODE: bed headboard on wall



A

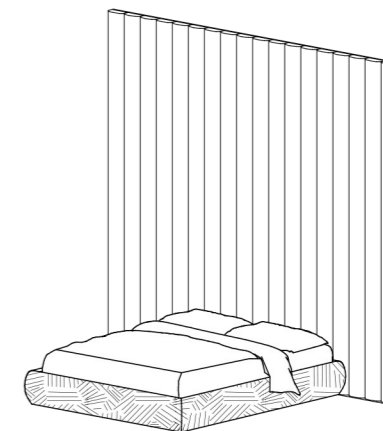

B



C

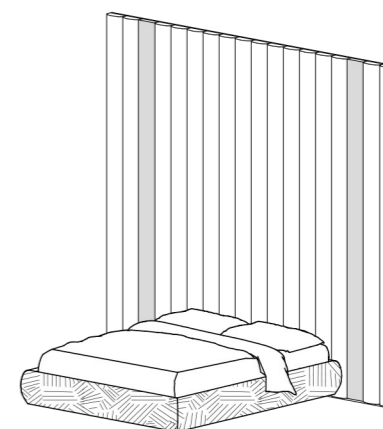

D

Letto DRESS CODE: testata con struttura
DRESS CODE: bed headboard with structure



E



F

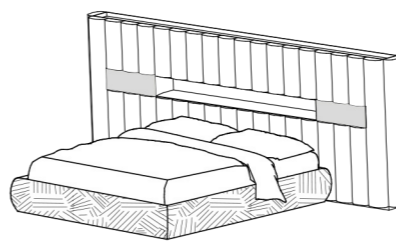

G

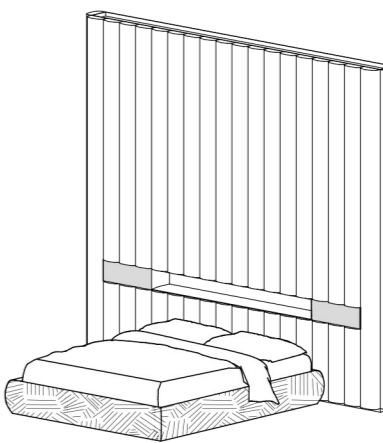

H

Doghe tessuto Vertical fabric panels

Doghe imbottite larghezza 18 cm. e spessore 8,5 cm. fissate con velcro.
Prevedere minimo 10 doghe per letto normal (L. 176) e 11 doghe per letto large (L. 196).

*Upholstered vertical panels 18 cm. wide and 8,5 cm. thick. Velcro assembly.
At least add 10 vertical panels for normal version (W. 176) and 11 vertical panels for large version (W. 196).*

Abbreviation:
tessuto cliente = client's fabric
finitura = finishing
pelle = leather

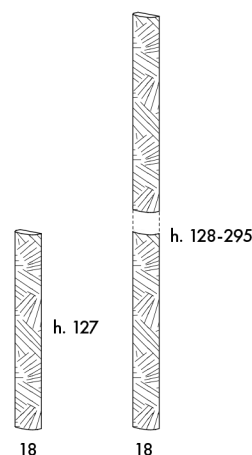

DIMENSIONE	COD.	FINITURA	CAT. A ECO-PELLE	CAT. B	CAT. C	CAT. D	PELLE EXTRA	PELLE VINTAGE	TESSUTO CLIENTE
h. 127	LE5554								
h. 128-295	LE5556								

Inserito metallo Metal inlay

Doghe laccate metallico spessore 5 cm. fissate con velcro.
Laquered metallic vertical panels 5 cm. thick assembled by velcro.

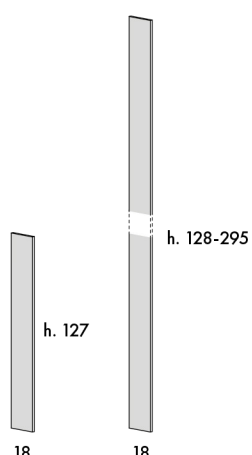

DIMENSIONE	COD.
h. 127	LE5558-A
h.128-295	LE5558-B

Accessori Accessories

Coppia faretti laccati metallici Led light couple metallic lacquered

Non serve aggiungere trasformatore No transformer needed

WATT	VOLT	CODICE
3+3w	220v	LED76

Coppia prese per nicchia orizzontale Plug couple for horizontal cavity

Ogni presa include 2 interruttori ed 1 presa usb. Each plug has 2 switches and 1 usb port

WATT	VOLT	CODICE
--	24v	LED75

Led nicchia box orizzontale Led light horizontal box*

La misura dipende dal numero di doghe. Size depends on the number of wall panels.

3000 K. - 10w/ml.

WATT	VOLT	CODICE
--	24v	LED74-NORMAL

WATT	VOLT	CODICE
--	24v	LED74-LARGE

Led vaschetta testata h. 130 cm. Led light for 130 cm. height headboard bowl*

3000 K. - 10w/ml.

WATT	VOLT	CODICE
--	--	LE5902

Caricatore wireless per vaschetta testata h. 130 Wireless charger for headboard bowl

Non serve aggiungere trasformatore

No transformer needed

WATT	VOLT	CODICE
--	--	LE5901

Trasformatore

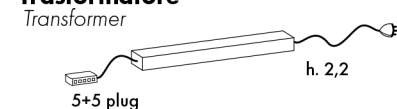

Calcolare la potenza trasformatore in base alla somma dei watt delle luci led.

WATT	VOLT	CODICE
30w	24v	ALIO4A

Calculate the transformer power considering the total watt of the led lights.

WATT	VOLT	CODICE
75w	24v	ALIO4B

* must be added an assigned transformer

Dress code bed: wall fixing

Testata a doghe imbottite Upholstered vertical panels for headboard

Esempi di componibilità testata Dress Code. A questi esempi è possibile aggiungere o togliere doghe imbottite. Il fissaggio delle doghe viene effettuato tramite velcro a parete. Doghe non sfoderabili.

Examples of modularity for Dress Code headboard. It is possible to add or remove upholstered vertical panels. Panels assembling is done by velcro stripes on wall. It is not possible to remove lining from wall panels.

Abbreviation:
finitura = finishing
pellet = leather
dimensione = heights
teessuto cliente = client's fabric

DRESS CODE

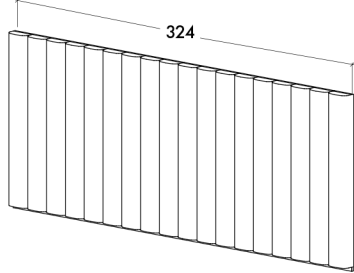
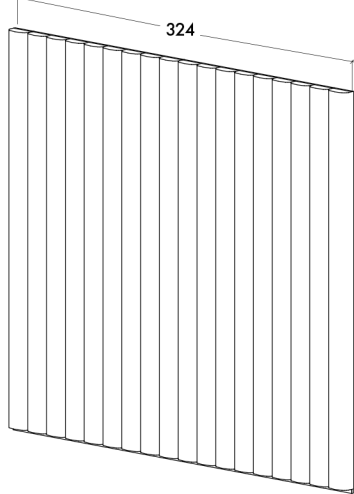
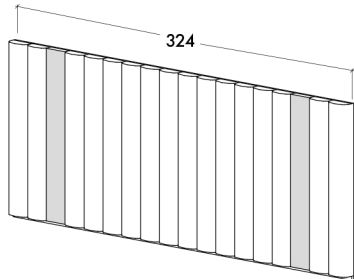
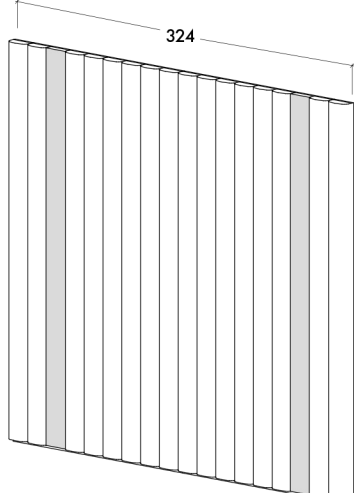
		DIMENSIONE	COD.	FINITURA	CAT. A ECO-PELLE	CAT. B	CAT. C	CAT. D	PELLE EXTRA	PELLE VINTAGE	TESSUTO CLIENTE
A	 <p>18 doghe - h. 127 cm. 18 vertical panels - h. 127 cm.</p>										
			h.127	LE551-A							
B	 <p>18 doghe - h. 128-295 cm. 18 vertical panels - h. 128-295 cm.</p>										
			h. 128-295	LE552-A							
C	 <p>16 doghe + 2 inserti metallici - h. 130 cm. 16 vertical panels + 2 metallic panels - h. 130 cm.</p>										
			h.127	LE551-B							
D	 <p>16 doghe + 2 inserti metallici - h. 128-295 cm. 16 vertical panels + 2 metallic panels - h. 128-295 cm.</p>										
			h. 128-295	LE552-B							

Dress code: headboard with structure

Testata con struttura distanziata e doghe imbottite *Headboard ahead from wall and with upholstered vertical panels*

Esempi di componibilità testata Dress Code. A questi esempi è possibile aggiungere o togliere doghe imbottite. Nelle strutture distanziate abbiamo un limite massimo di 27 doghe (larghezza massima 486 cm.). Il fissaggio delle doghe viene effettuato tramite velcro alla struttura.

Examples of modularity for Dress Code headboard. It is possible to add or remove upholstered vertical panels. Headboard ahead from wall can be assembled with max 27 upholstered vertical panels (max width 486 cm.). Panels assembling is done by velcro stripes on structure.

Abbreviation:
finitura = finishing
pelles = leather
dimensione = heights
teessuto cliente = client's fabric

DRESS CODE

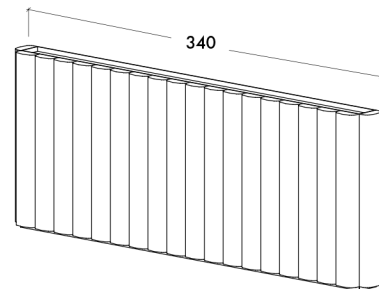
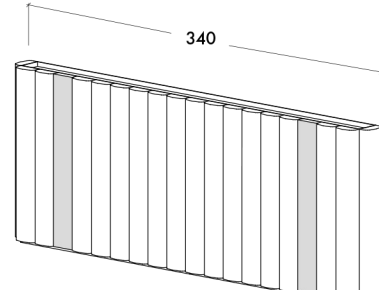
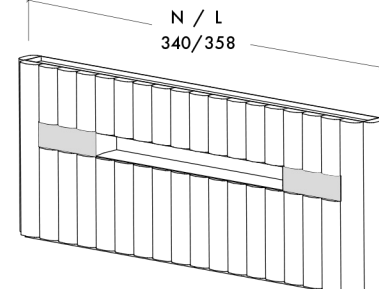
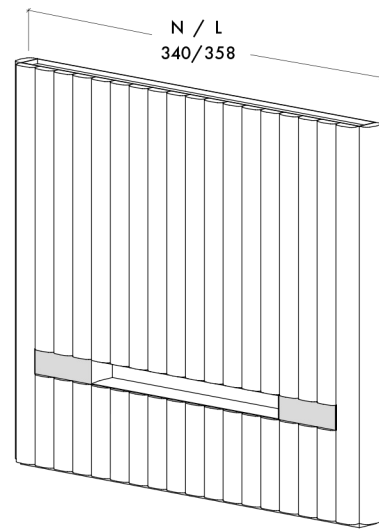
		DIMENSIONE	COD.	FINITURA	CAT. A ECO-PELLE	CAT. B	CAT. C	CAT. D	PELLE EXTRA	PELLE VINTAGE	TESSUTO CLIENTE
E	 <p>Struttura distanziata con 2 vaschette superiori 18 doghe + 2 doghe laterali - h. 130 cm. <i>Headboard ahead from wall with 2 upper open units</i> 18 vertical panels + 2 lateral panels - h. 130 cm.</p>	h.130 NORMAL	LE561-AN								
F	 <p>Struttura distanziata con 2 vaschette superiori 16 doghe + 2 doghe laterali + 2 inserti metallici - h. 130 cm. <i>Headboard ahead from wall with 2 upper open units</i> 16 vertical panels + 2 lateral panels + 2 metallic panels - h. 130 cm.</p>	h.130 NORMAL	LE561-BN								
G	 <p>Versione NORMAL - h.130 cm. Struttura distanziata con 2 vaschette superiori 18 doghe + 2 doghe laterali + inserto orizzontale NORMAL version - h. 130 cm. <i>Headboard ahead from wall with 2 upper open units</i> 18 vertical panels + 2 lateral panels + horizontal frame -</p> <p>Versione LARGE- h.130 cm. Struttura distanziata con 2 vaschette superiori con 19 doghe + 2 doghe laterali + inserto orizzontale LARGE version - h. 130 cm. <i>Headboard ahead from wall with 2 upper open units</i> 19 vertical panels + 2 lateral panels + horizontal frame</p>	h.130 NORMAL	LE561-CN								
		h.130 LARGE	LE561-CL								
H	 <p>Versione NORMAL - h.295 -131 cm. Struttura distanziata con 18 doghe + 2 doghe laterali - + inserto orizzontale NORMAL version- h. 295 -131 cm. <i>Headboard ahead from wall with 18 vertical panels + 2 lateral panels + horizontal frame</i></p> <p>Versione LARGE - h.295 -131 cm. Struttura distanziata con 19 doghe + 2 doghe laterali - + inserto orizzontale LARGE version - h. 295 -131 cm. <i>Headboard ahead from wall with 19 vertical panels + 2 lateral panels + horizontal frame</i></p>	h. 131-295 NORMAL	LE562-CN								
		h. 131-295 LARGE	LE562-CL								

Letto Dress Code Dress Code Bed

Tessuto occorrente per rivestire sommier:

Normal: tessuto 5.5 x h. 1,40 mtl.; pelle mq. 9 / Large: tessuto 6 x h. 1,40 mtl.; pelle mq. 9.

Rete e materasso esclusi. Consigliato materasso 160/180 x 200 cm. (N.B.: Reti e materassi pag. 82-83).

Requested fabric to upholster the sommier:

Normal: fabric 5.5 x h. 1,40 linear meters; leather squared meters 9 / Large: fabric linear meters. 6 x h. 1,40; leather squared meters 9.

Bed base and mattress excluded: suggested version 160/180 x 200 cm. (IMP.: Bed bases and mattresses page 82-83).

Abbreviation:

dimensione = heights

finitura = finishing

frontale = fronts

pelle = leather

sovrapprezzo = surcharge

struttura = structure

tessuto cliente = client's fabric

DRESS CODE

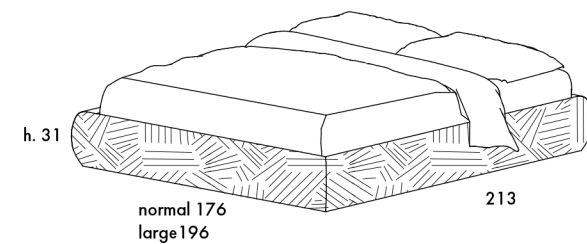

DIMENSIONE	COD.	FINITURA	CAT. A ECO-PELLE	CAT. B	CAT. C	CAT. D	PELLE EXTRA	PELLE VINTAGE	TESSUTO CLIENTE
NORMAL	LE550 - N								
LARGE	LE550 - L								

Letto Dress Code con vano contenitore Dress Code Bed with storage

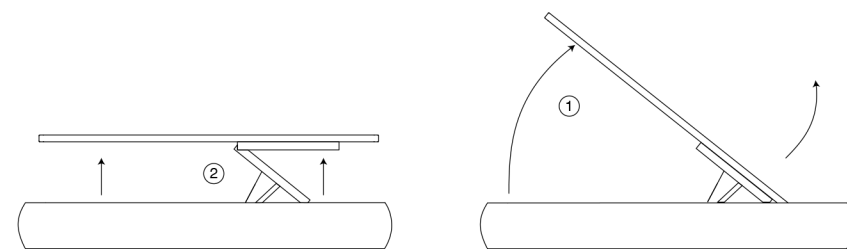

DIMENSIONE	COD.	FINITURA	CAT. A ECO-PELLE	CAT. B	CAT. C	CAT. D	PELLE EXTRA	PELLE VINTAGE	TESSUTO CLIENTE
NORMAL	LE560 - N								
LARGE	LE560 - L								

Rete contenitore a 2 movimenti: sistema di doppia apertura con messa in piano: verticale per accesso al contenitore ed orizzontale per posizionamento a rifacimento letto.

2 positions bed base: vertical for bed's storage access and horizontal to help you making the bed.

Comodino, comò

Bedside table, chest of drawers

Gruppo con struttura in MDF rastremata in laccato opaco/lucido o metallico. Top in rovere. Frontali in rovere con personalizzazione 10:2 opzionale. Interno cassetti alpha.

Night complements with MDF structure in mat lacquer / glossy or metallic finishing. Top in oak. Fronts with 10:2 engravings available. Internal drawers in alpha finishing.

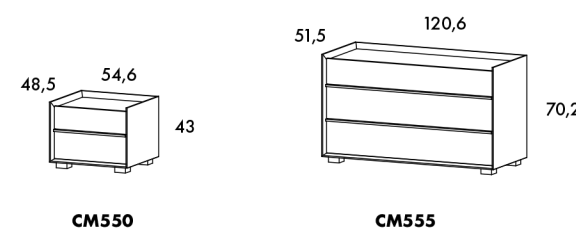
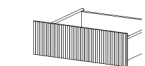

COD.	STRUTTURA FRONTALE/ TOP	CAT. 2/4	CAT. 3	SOVRAPPREZZO 10:2 FRONTALI CAT. 5
CM550				
CM555				

FINITURE TESSUTI

FABRIC FINISHING

Cat. A Ecopelle

A category Eco leather

Spalmatura (front) 100% PVC; Supporto (back) 50% PES - 50% CO

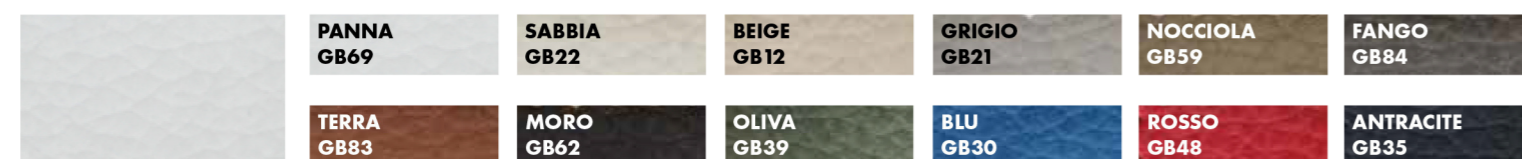

Cat. A Cotone

A category Cotton

100% CO



Cat. B Canvas

B category Canvas

100% PL tratt. FR / with FR backing



Cat. C Mumble

C category Mumble

72% RPET; 28% PL



Cat. C Wool

C category Wool

100% PL tratt. FR / with FR backing



Cat. D Grain

D category Grain

100% PL riciclato / recycled



Cat. Pelle Extra

Category Extra leather

Pelli di provenienza europea, conciate al cromo, tinte in botte con aniline e rifinite a pieno fiore, leggermente rettificata. Spessore 1,1-1,3 mm.
Full grain leather of european origin, chrome tanning processed, painted in barrel with aniline. Thickness 1.1-1.3 mm.



Cat. Pelle Vintage

Category Vintage leather

Pelli di provenienza europea, ad effetto invecchiato. Questo articolo di alta qualità è ottenuto partendo da una pelle nabuck, che viene leggermente ugualizzata con aniline ed abrasivata a mano per dare un effetto invecchiato. La mano è molto calda e setosa. Spessore 0,9-1,1 mm.
Full grain leather of european origin, aged effect. This is a high quality item made by a nubuck leather, brushed by hand, so uneven and aged final effect. The touch is smooth and warm. Thickness 0.9-1.1 mm.

