

ASTIPALEA_HINGED DOOR

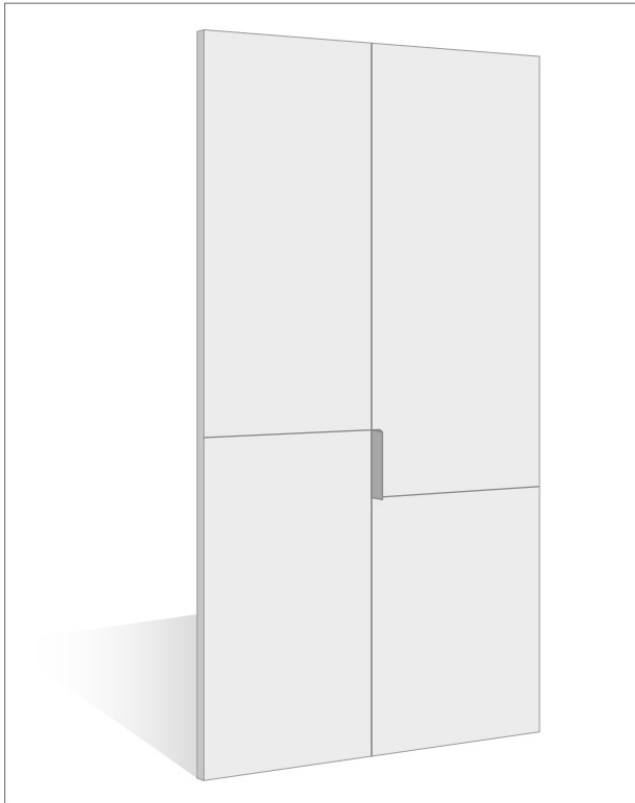
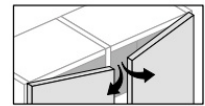

FRONTS

- matt lacquered

TECHNICAL SPECIFICATIONS

The Astipalea hinged door consists of:
 - a 22mm-1" thick MDF panel with low formaldehyde content.
 - horizontal incisions.

HANDLE AND INCISION DETAIL

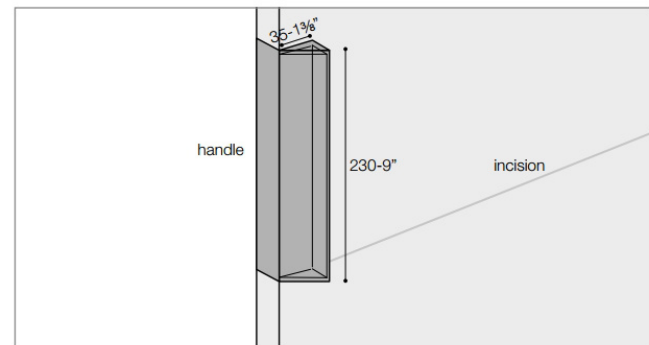

HANDLE

- matt lacquered
 - wood

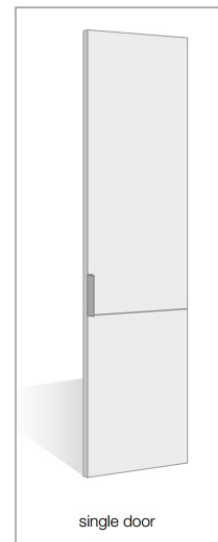
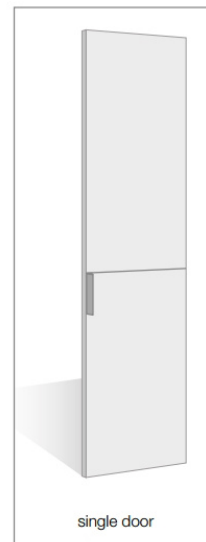
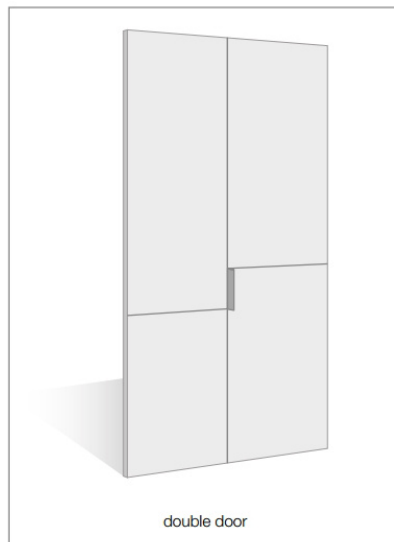
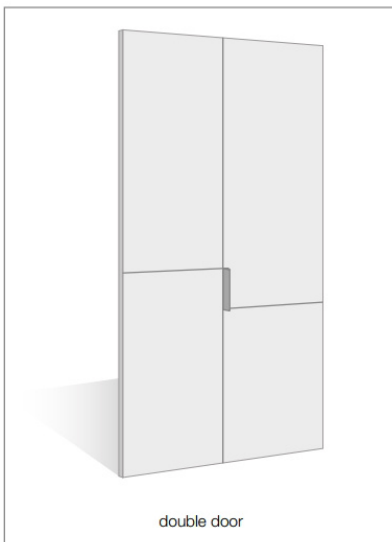

DOOR SIZES

	H. 2384-93 ⁷ / ₈ "	H. 2544-100 ¹ / ₂ "	H. 2896-114"
W. 450-17 ³ / ₄ "	•	•	•
W. 500-19 ⁵ / ₈ "	•	•	•
W. 600-23 ⁵ / ₈ "	•	•	•

- = AVAILABLE
- = NOT AVAILABLE

CUSTOM PROCESSINGS ARE NOT POSSIBLE

HINGED DOOR WARDROBE

DIMENSIONAL CHARACTERISTICS

HEIGHT

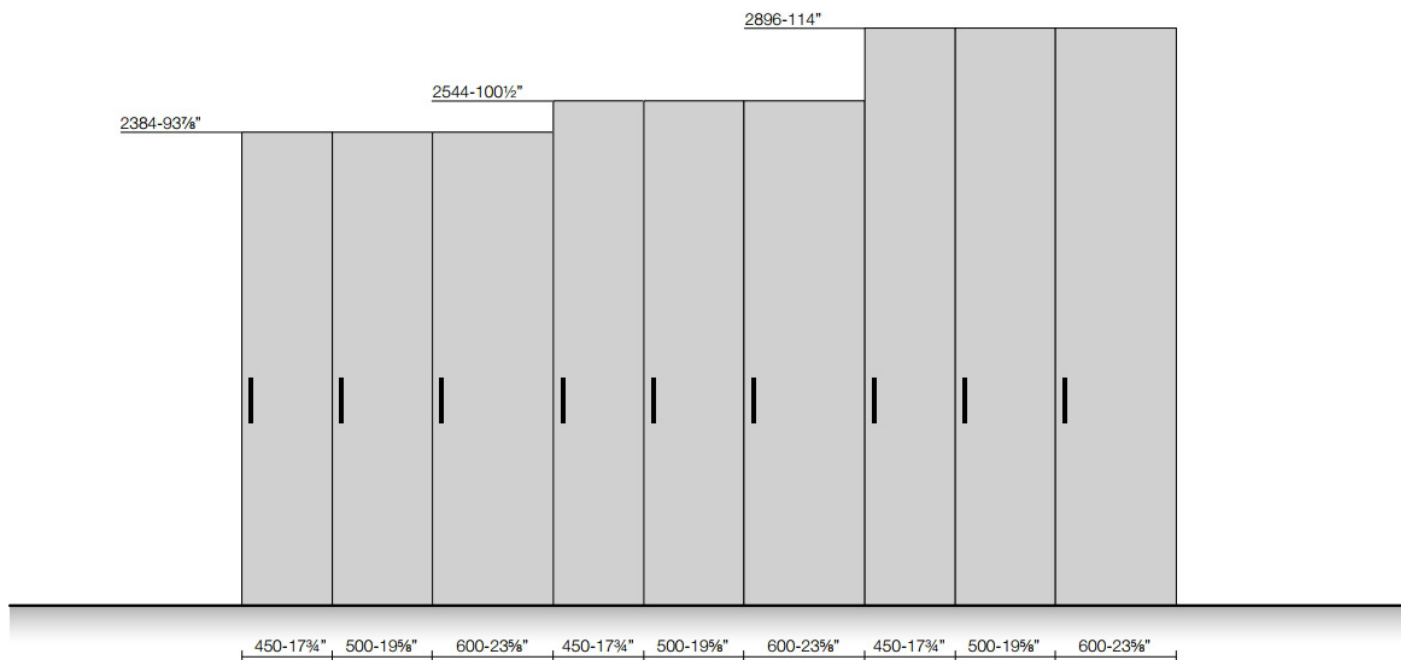

STRUCTURE WIDTH AND DEPTH (EXCLUDING DOOR)

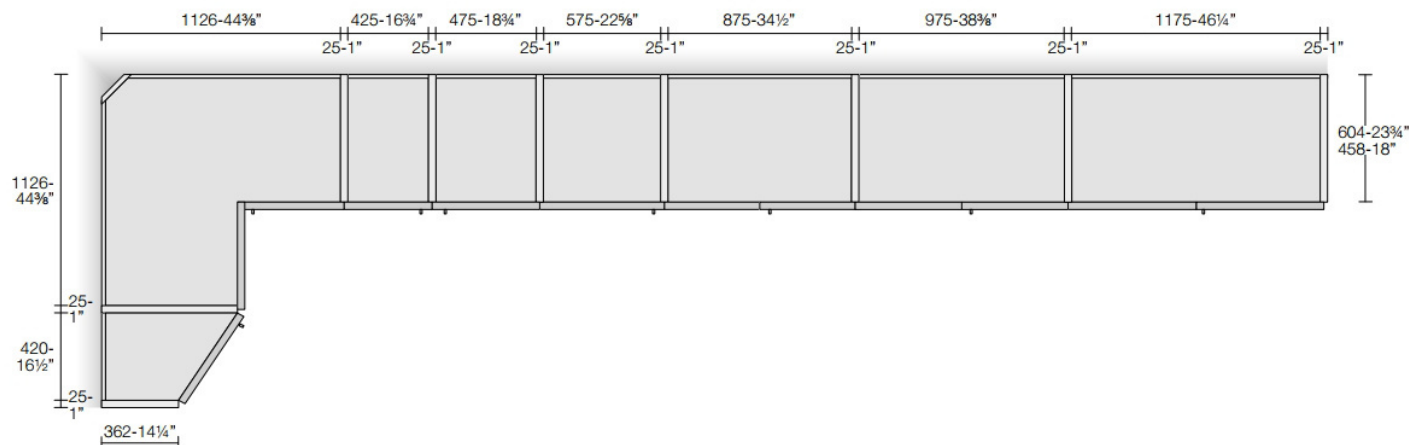

- All wardrobes are supplied with a base made of metal profiles and adjustable feet that ensure, besides quick assembly, excellent and durable stability as well as perfect door closure. The framework is supplied in a single piece the same length as the wardrobe up to a maximum length of 4.975 mm.
- The removable bottom panel allows easy cleaning and can be used as a secret compartment; it is not available in compartments with drawer packs, interior partitions and in wardrobes with coplanar sliding doors.
- **The price of the modules always includes a structural shelf and two standard clothes hanger rails.**
- **The price of the module with side depth reduced to 458-18" mm, is equal to the price of the module with standard depth.**
- **The price of the modules also includes the plinth.**

HINGED DOOR WARDROBE

SIDE

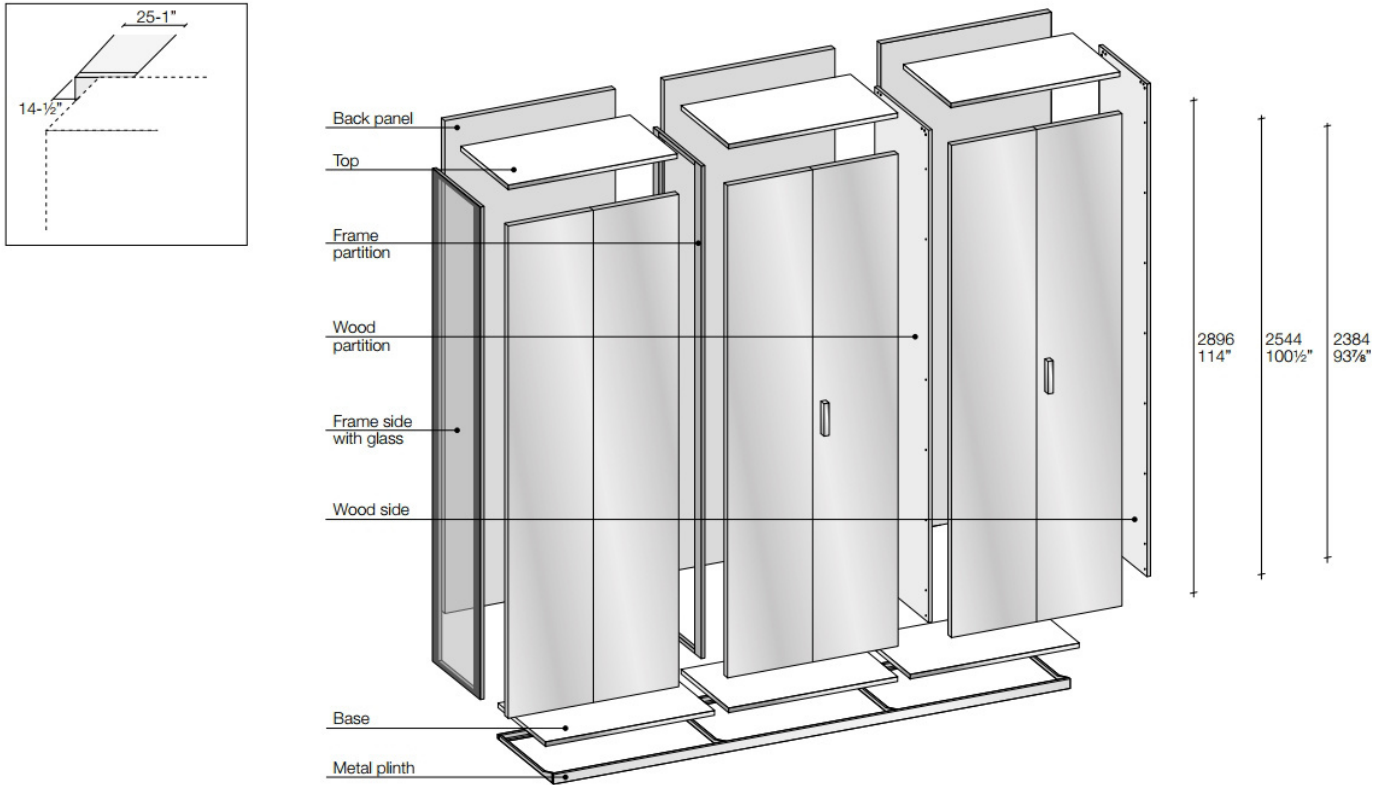

Constant holes at 64-2½" mm pitch (standard)

Holes only on the shelves. The positioning of the shelves will always follow the reference hole at a pitch of 64-2½" mm (on request)

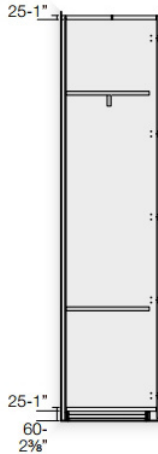
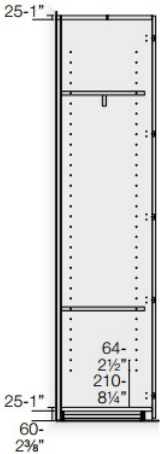

The holes only on the shelves will be supplied on request and at the same price and a drawing with the necessary dimensions must be provided by you, always following the reference holes at a pitch of 64-2½" mm.

ASSEMBLY CHARACTERISTICS

To assemble the wardrobe, a space of 30-1⅞" mm in width is required for all the opening systems.

A space of 25-1" mm in height is required to assemble the hinged wardrobe.

To assemble the sliding and coplanar wardrobe, this height space is required:

+ 40mm / 1⅝"
for assembly of the doors

+ 70mm / 2¾"
for easy adjustment

Space occupied by the mechanisms of the sliding and coplanar wardrobe in height for the external assembly and subsequent insertion in the recess:

+ 30mm / 1⅞"

our wardrobes
have been
made to rest
on three solid
foundational ideas:

stability
adjustability
reliability



The aluminium base not only allows quick and simple assembly, but also facilitates any disassembly operations for any time you might move house.

WARDROBES PROGRAM PRESENTATION



Adjustment and levelling foot with a capacity of 100-3 $\frac{3}{8}$ " kg. The adjustment is transmitted along the entire length of the frame in order to avoid imbalances typical of traditional wardrobes with wooden base. The possible adjustment is from 0 to 12mm- $\frac{1}{2}$ "1.

The entire wardrobe distributes the weight uniformly on the structure, ensuring stability over time.



The aluminium profile has a section with differentiated sealing and reinforced points absorb the various pressures of the system.



The removable base allows facilitates cleaning and can also be used as a secret compartment.

GLAMOUR	ELEGANCE	NATURAL
 Bianco giglio	 Bianco neve	 Alloro
 Corda	 Grigio agata	 Verde quarzo
 Tortora	 Grigio polvere	 Verde salvia
 Beige fango	 Grigio nebbia	 Verde timo
 Beige argilla	 Grigio tasmania	
 Marrone corteccia	 Grigio Londra	
 Beige gypso	 Anthracite Gray	
 Grisbeige	 Nero frac	
 Comfort		
 Grigio creta		
 Titanio		

HARMONY

ROMANTIC

ENERGY



CONFORMITY TO SAMPLE

Conformity to the sample should not be understood in an absolute sense since there are margins of tolerance due to product variations (colors, materials, sizes) or caused by environmental factors (light, humidity, etc.). In case of completion of the order at a later time, perfect equality of colors and/or coatings between the original composition and the additional elements is not guaranteed.

N.B.: reproduction of colors on paper may show slight color differences from the originals.

FINISHES

Vetro satinato o lucido retrolaccato
Satin-finished or polished back-lacquered glass

GLAMOUR

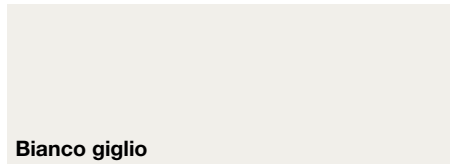

ELEGANCE

