

# AIR SOFT FREE SOFA - BASI PER SCHIENALI SELF-STANDING//BASES FOR SELF-STANDING BACKRESTS

Categorie  
Categories

A: Tessuto cliente.  
A: Customer's fabric.

B: Darwin. Please, Ecopelle Bloom.  
B: Darwin. Please, Bloom Faux leather.

C: Francis, Axum, Barkley, Frosty, Penny, Barnum, Club.  
C: Francis, Axum, Barkley, Frosty, Penny, Barnum, Club.

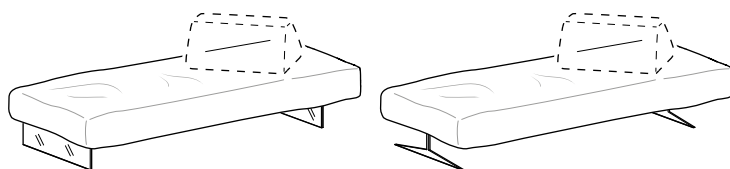

Gambe in vetro extra-chiaro  
Extra-clear glass legs

Gambe in acciaio Peltro steel o Titanio steel.  
Steel legs in Peltro Steel or Titanio Steel.

		Gambe Legs	Codice Code	A	B	C	m
	L/W						
	P/D						
<b>170</b>	<b>105</b>	vetro glass metallo metal	ND0065				3,5
	L/W						
	P/D						
<b>200</b>	<b>105</b>	vetro glass metallo metal	ND0066				5
	L/W						
	P/D						
<b>230</b>	<b>105</b>	vetro glass metallo metal	ND0067				5
	L/W						
	P/D						
<b>270</b>	<b>105</b>	vetro glass metallo metal	ND0068				6,2
	L/W						
	P/D						
<b>300</b>	<b>105</b>	vetro glass metallo metal	ND0069				6,5

# AIR SOFT FREE SOFA - BASI PER SCHIENALI SELF-STANDING//BASES FOR SELF-STANDING BACKRESTS

Categorie  
Categories

A: Tessuto cliente.  
A: Customer's fabric.

B: Darwin. Please, Ecopelle Bloom.  
B: Darwin. Please, Bloom Faux leather.

C: Francis, Axum, Barkley, Frosty, Penny, Barnum, Club.  
C: Francis, Axum, Barkley, Frosty, Penny, Barnum, Club.

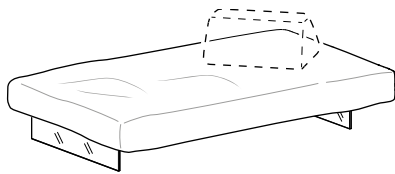

Gambe in vetro extra-chiaro  
Extra-clear glass legs

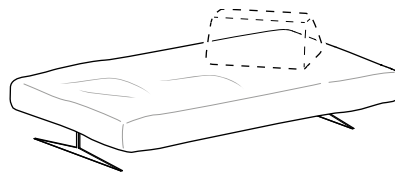

Gambe in acciaio Pelro steel o Titanio steel.  
Steel legs in Pelro Steel or Titanio Steel.

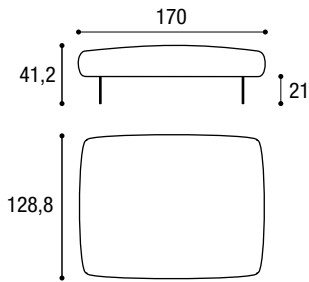

L/W P//D

**170 128,8**

Gambe  
Legs

vetro  
glass  
metallo  
metal

Codice  
Code

ND0070

A

B

C

 m

4

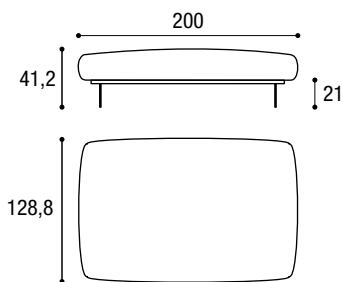

**200 128,8**

vetro  
glass  
metallo  
metal

ND0071

4,8

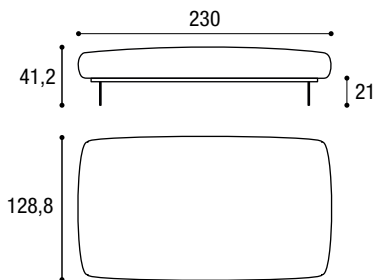

**230 128,8**

vetro  
glass  
metallo  
metal

ND0072

5,3

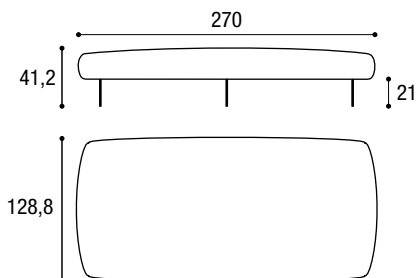

**270 128,8**

vetro  
glass  
metallo  
metal

ND0073

6,3

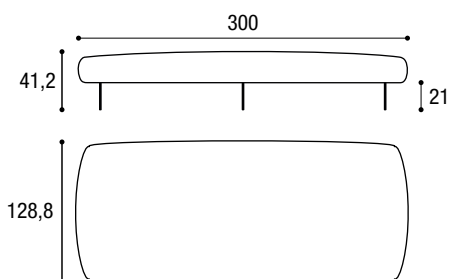

**300 128,8**

vetro  
glass  
metallo  
metal

ND0074

6,8

## AIR SOFT FREE SOFA - SCHIENALI SELF-STANDING//SELF-STANDING BACKRESTS

Categorie **A:** Tessuto cliente. **B:** Darwin. Please, Ecopelle Bloom. **C:** Francis, Axum, Barkley, Frosty, Penny, Barnum, Club.  
 Categories **A:** Customer's fabric. **B:** Darwin. Please, Bloom Faux leather. **C:** Francis, Axum, Barkley, Frosty, Penny, Barnum, Club.

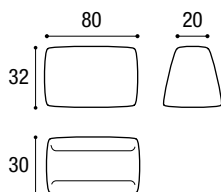
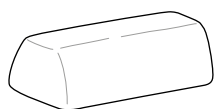

L//W	P//D	Codice Code	A	B	C	m
80	30	ND0075				1,30
90	30	ND0076				1,50
100	30	ND0077				1,70

## AIR SOFT FREE SOFA - ESEMPI DI COMPOSIZIONI//COMPOSITION EXAMPLES

Categorie **A:** Tessuto cliente. **B:** Darwin. Please, Ecopelle Bloom. **C:** Francis, Axum, Barkley, Frosty, Penny, Barnum, Club.  
 Categories **A:** Customer's fabric. **B:** Darwin. Please, Bloom Faux leather. **C:** Francis, Axum, Barkley, Frosty, Penny, Barnum, Club.

2714

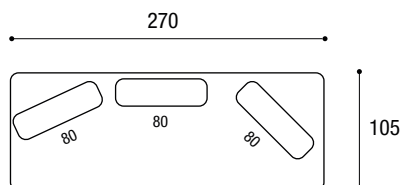

Composizione Composition	L//W	P//D	A//H	Codice Code	A	B	C
2714	270	105	73,2	271401			

2715

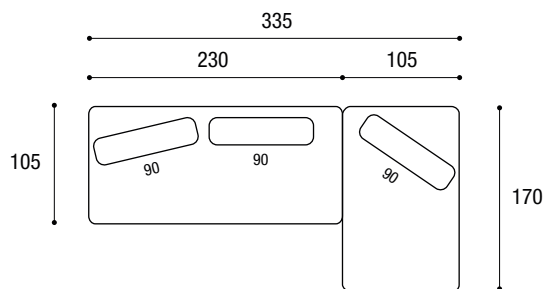

Composizione Composition	L//W	P//D	A//H	Codice Code	A	B	C
2715	335	170	73,2	271501			

# AIR SOFT FREE SOFA - ESEMPI DI COMPOSIZIONI//COMPOSITION EXAMPLES

Categorie  
Categories

A: Tessuto cliente.  
A: Customer's fabric.

B: Darwin. Please, Ecopelle Bloom.  
B: Darwin. Please, Bloom Faux leather.

C: Francis, Axum, Barkley, Frosty, Penny, Barnum, Club.  
C: Francis, Axum, Barkley, Frosty, Penny, Barnum, Club.

2716

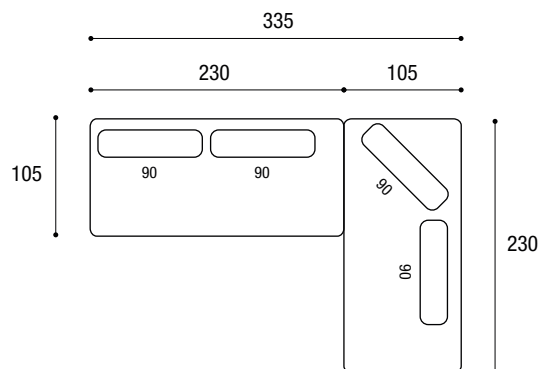

Composizione Composition	L//W	P//D	A//H	Codice Code	A	B	C
2716	335	230	73,2	271601			

1917\*

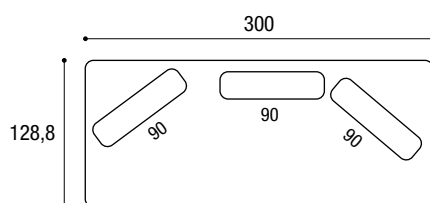

Prezzo calcolato con telaio con sostegni in metallo.  
Price calculated with frame with metal supports.

Composizione Composition	L//W	P//D	A//H	Codice Code	A	B	C
1917	300	128,8	73,2	191701			
Cuscino a saponetta quadrata//Square soap-shaped cushion	36,8	12	36,8	DI5071			

1916\*

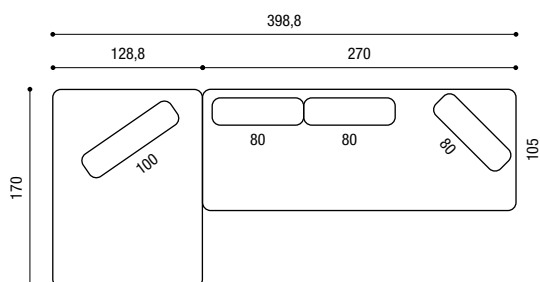

Composizione Composition	L//W	P//D	A//H	Codice Code	A	B	C
1916	398,8	170	73,2	191601			
Cuscino a saponetta quadrata//Square soap-shaped cushion n°2 (prezzo cad.//price each.)	36,8	12	36,8	DI5071			

2694A\*

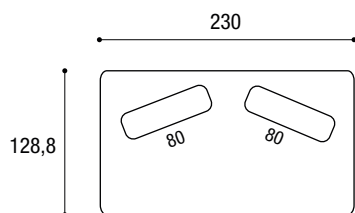

Prezzo calcolato con telaio con sostegni in metallo.  
Price calculated with frame with metal supports.

2694B\*

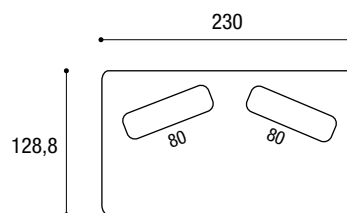

Prezzo calcolato con telaio con sostegni in metallo.  
Price calculated with frame with metal supports.

Composizione Composition	L//W	P//D	A//H	Codice Code	A	B	C
2694A	230	128,8	73,2	269401			
2694B	230	128,8	73,2	269402			

\* Composizione a catalogo  
\* Catalogue composition

Prezzi calcolati con telaio con sostegni in vetro, salvo dove specificato.  
Prices calculated with frame with glass supports, unless specified otherwise.

## AIR SOFT FREE SOFA - ESEMPI DI COMPOSIZIONI//COMPOSITION EXAMPLES

Categorie  
Categories

A: Tessuto cliente.  
A: Customer's fabric.

B: Darwin. Please, Ecopelle Bloom.  
B: Darwin. Please, Bloom Faux leather.

C: Francis, Axum, Barkley, Frosty, Penny, Barnum, Club.  
C: Francis, Axum, Barkley, Frosty, Penny, Barnum, Club.

2695\*

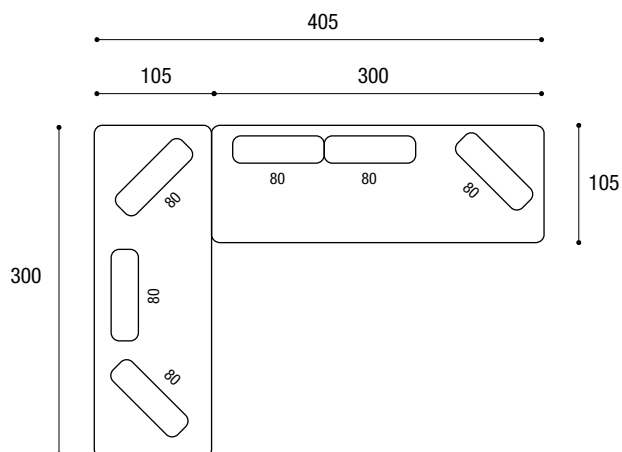

Composizione Composition		L//W	P//D	A//H	Codice Code	A	B	C
<b>2695</b>		<b>405</b>	<b>300</b>	<b>73,2</b>	<b>269501</b>			
Cuscino a saponetta quadrata//Square soap-shaped cushion n°3 (prezzo cad./price each.)		<b>36,8</b>	<b>12</b>	<b>36,8</b>	<b>DI5071</b>			

2697\*

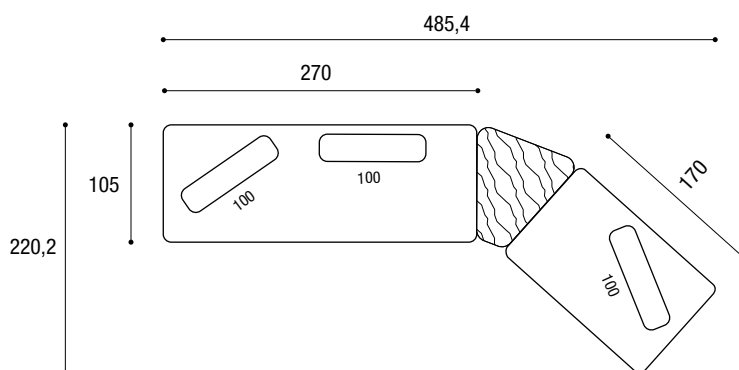

Prezzo calcolato con telaio con sostegni in metallo.  
Price calculated with frame with metal supports.

Composizione Composition		L//W	P//D	A//H	Codice Code	A	B	C
<b>2697</b>		<b>485,4</b>	<b>220,2</b>	<b>73,2</b>	<b>269701</b>			
Cuscino a saponetta quadrata//Square soap-shaped cushion		<b>36,8</b>	<b>12</b>	<b>36,8</b>	<b>DI5071</b>			
Cuscino a saponetta quadrata//Square soap-shaped cushion n°2 (prezzo cad./price each.)		<b>46</b>	<b>12</b>	<b>46</b>	<b>DI5072</b>			

2722\*

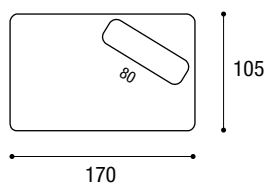

Prezzo calcolato con telaio con sostegni in metallo.  
Price calculated with frame with metal supports.

Composizione Composition		L//W	P//D	A//H	Codice Code	A	B	C
<b>2722</b>		<b>170</b>	<b>105</b>	<b>73,2</b>	<b>272201</b>			