

AIR SOFA

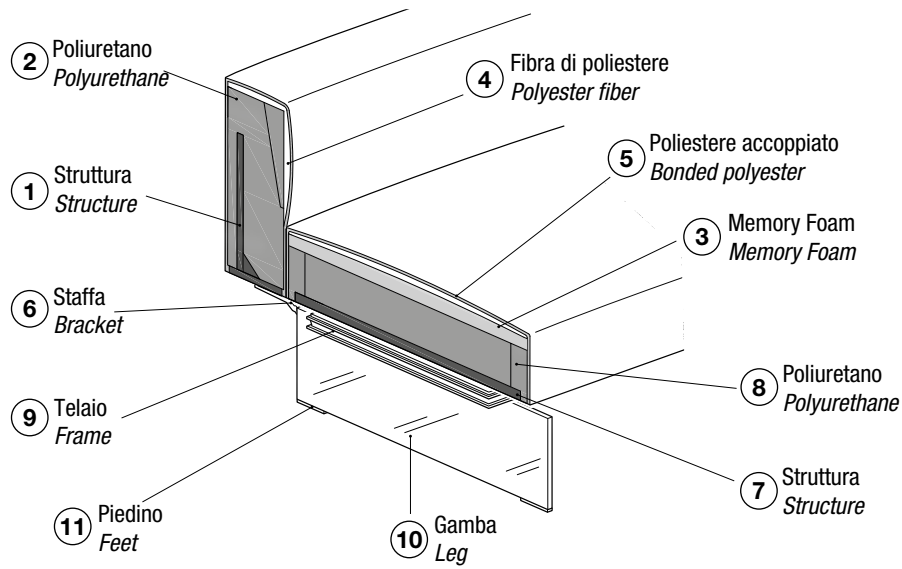

Componenti//Components

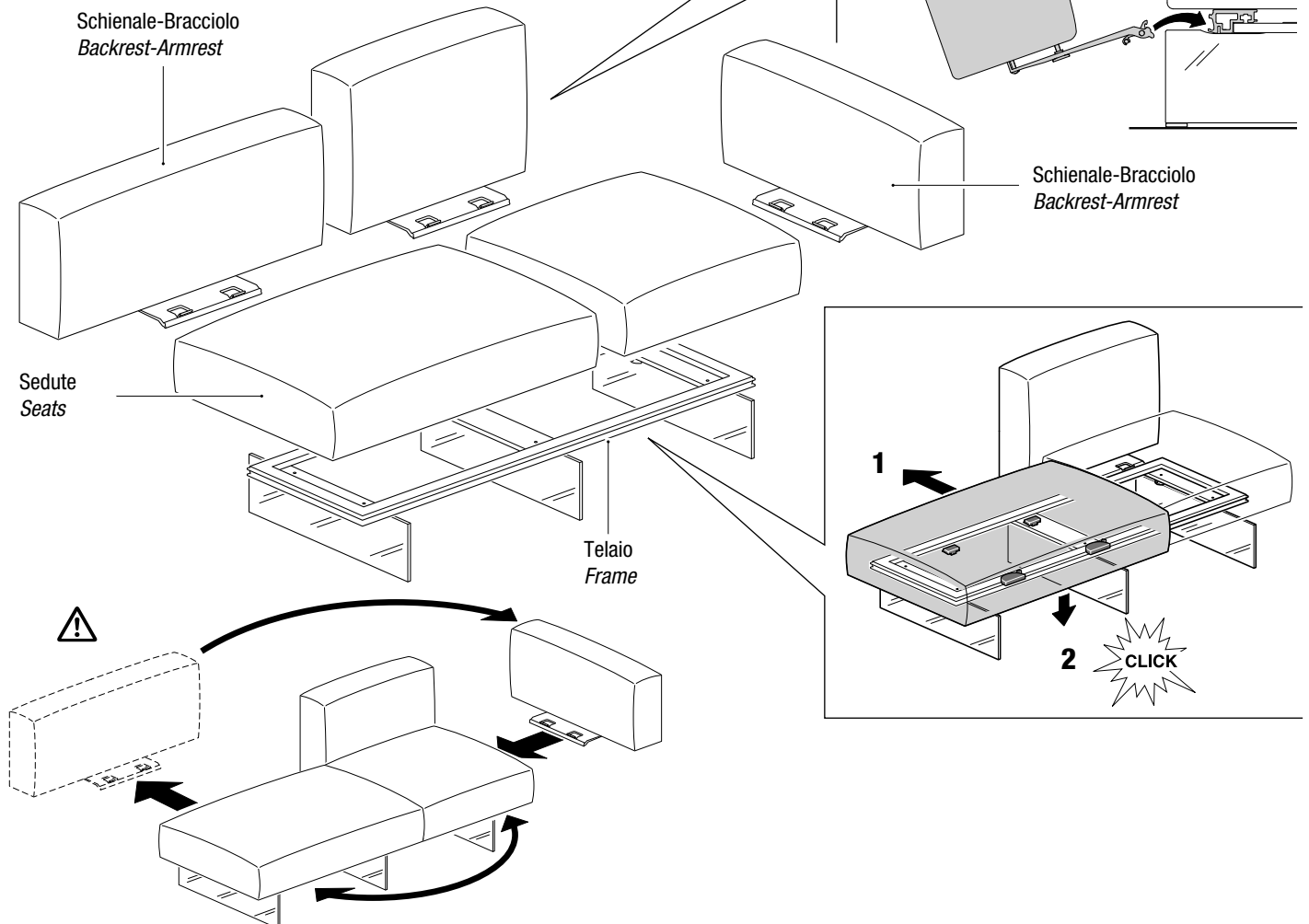

AIR SOFA DIVANI CENTRALI//AIR CENTRE SOFAS

Categorie **A:** Tessuto cliente.
Categories **A:** Customer's fabric.

B: Darwin. Please, Ecopelle Bloom.
B: Darwin. Please, Bloom Faux leather.

C: Francis, Axum, Barkley, Frosty, Penny, Barnum, Club.
C: Francis, Axum, Barkley, Frosty, Penny, Barnum and Club.

P: Pelle Panama.
P: Panama leather.

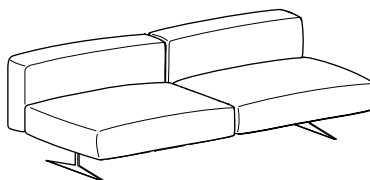
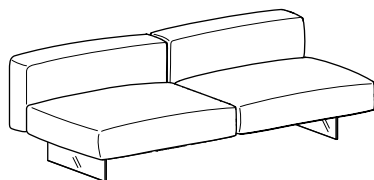

Gambe in vetro extra-chiaro o fumé grigio.
Legs in extra-clear or smoked grey glass.

Gambe in acciaio Peltro steel o Titanio steel.
Steel legs in Peltro Steel or Titanio Steel.

L//W P//D		Gambe Legs	Codice Code	A	B	C	P	m	m ²
	184 101,2	vetro glass metallo metal	ND1003					7,4	8,4
	220,8 101,2	vetro glass metallo metal	ND1005					8,95	10,1
	257,6 101,2	vetro glass metallo metal	ND1007					10,6	11,7
	294,4 101,2	vetro glass metallo metal	ND1009					12	13,3
	331,2 101,2	vetro glass metallo metal	ND1010					13,5	15,6

180 Imbottitura e tessuti ignifughi disponibili su richiesta.
Fire-resistant padding and fabrics available on request.

PELLE: moduli L 147,2 e 184 cm hanno 1 cucitura. Moduli L 220,8 cm hanno 2 cuciture.
LEATHER: the L 147.2 and 184 cm modules have 1 seam. The L 220.8 cm modules have 2 seams.

AIR SOFA CHAISE LONGUE CENTRALI//AIR CENTRE CHAISE LONGUES

Categorie **A:** Tessuto cliente.
Categories **A:** Customer's fabric.

B: Darwin. Please, Ecopelle Bloom.
B: Darwin. Please, Bloom Faux leather.

C: Francis, Axum, Barkley, Frosty, Penny, Barnum, Club.
C: Francis, Axum, Barkley, Frosty, Penny, Barnum and Club.

P: Pelle Panama.
P: Panama leather.

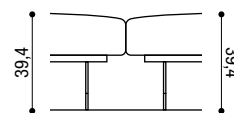
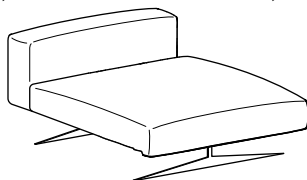
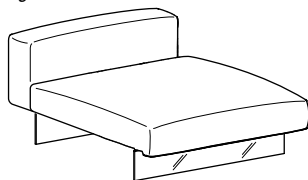

Chaise longue **Divano Sofa**

Gambe in vetro extra-chiaro o fumé grigio.
Legs in extra-clear or smoked grey glass.

Gambe in acciaio Peltro steel o Titanio steel.
Steel legs in Peltro Steel or Titanio Steel.

Gambe vetro//Glass legs

Gambe metallo//Metal legs

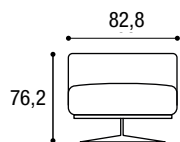
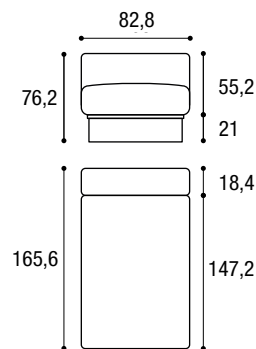

Gambe vetro//Glass legs

Gambe metallo//Metal legs

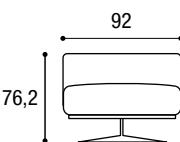
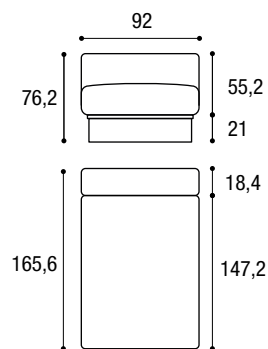

Gambe vetro//Glass legs

Gambe metallo//Metal legs

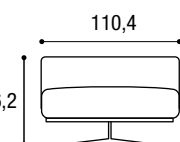
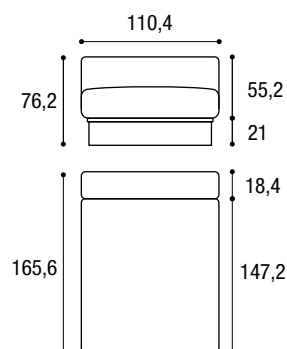

Gambe vetro//Glass legs

Gambe metallo//Metal legs

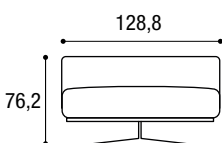
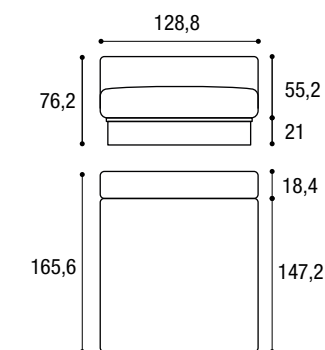

Imbottitura e tessuti ignifughi disponibili su richiesta.
Fire-resistant padding and fabrics available on request.

L//W	P//D	Gambe Legs	Codice Code	A	B	C	P	m	m ²
82,8	165,6	vetro glass metallo metal	ND1015					4,7	5,3
92	165,6	vetro glass metallo metal	ND1016					4,9	5,5
110,4	165,6	vetro glass metallo metal	ND1017					4,55	5,65
128,8	165,6	vetro glass metallo metal	ND1018					5,6	6,25

AIR SOFA DIVANI CENTRALI CON POUF//AIR CENTRE SOFAS WITH POUF

Categorie **A:** Tessuto cliente.
Categories **A:** Customer's fabric.

B: Darwin. Please, Ecopelle Bloom.
B: Darwin. Please, Bloom Faux leather.

C: Francis, Axum, Barkley, Frosty, Penny, Barnum, Club.
C: Francis, Axum, Barkley, Frosty, Penny, Barnum and Club.

P: Pelle Panama.
P: Panama leather.

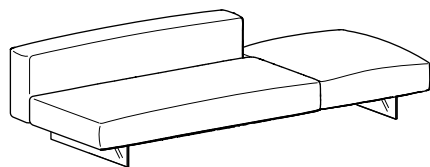

Gambe in vetro extra-chiaro o fumé grigio.
Legs in extra-clear or smoked grey glass.

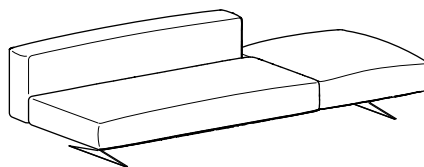

Gambe in acciaio Peltro steel o Titanio steel.
Steel legs in Peltro Steel or Titanio Steel.

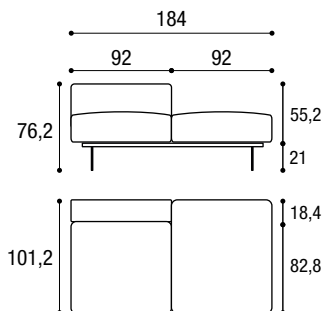

L/W P//D

184 101,2

**Gambe
Legs**

**Codice
Code**

A

B

C

P

m

m²

vetro
glass
metallo
metal

ND1011

6

7

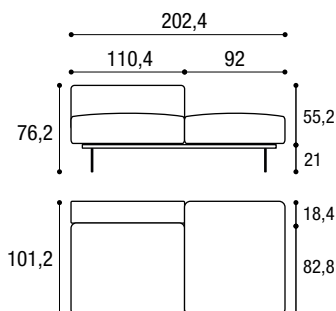

202,4 101,2

vetro
glass
metallo
metal

ND1012

6,75

7,9

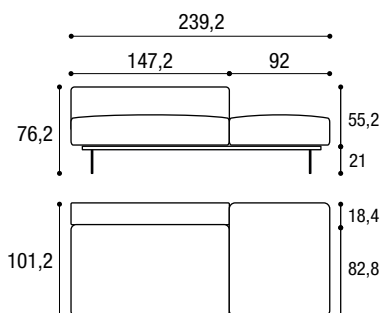

239,2 101,2

vetro
glass
metallo
metal

ND1013

8,25

9,35

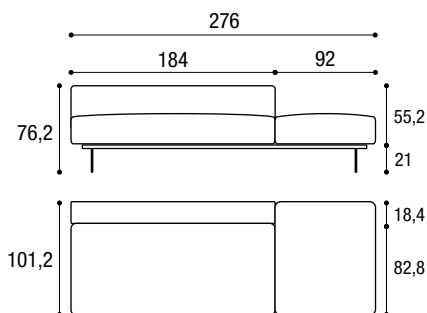

276 101,2

vetro
glass
metallo
metal

ND1014

9,65

11,1

AIR SOFA DIVANI CENTRALI CON TAVOLINO//AIR CENTRE SOFAS WITH OCCASIONAL TABLE

Categorie
Categories

A: Tessuto cliente.
A: Customer's fabric.

B: Darwin. Please, Ecopelle Bloom.
B: Darwin. Please, Bloom Faux leather.

C: Francis, Axum, Barkley, Frosty, Penny, Barnum, Club.
C: Francis, Axum, Barkley, Frosty, Penny, Barnum and Club.

P: Pelle Panama.
P: Panama leather.

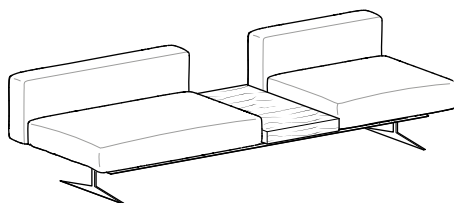
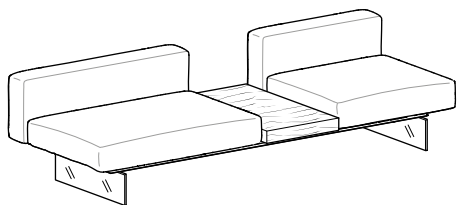

Gambe in vetro extra-chiaro o fumé grigio.
Legs in extra-clear or smoked grey glass.

Gambe in acciaio Peltro steel o Titanio steel.
Steel legs in Peltro Steel or Titanio Steel.

Indicare:
colore top Wildwood.

Indicare:
Wildwood top colour.

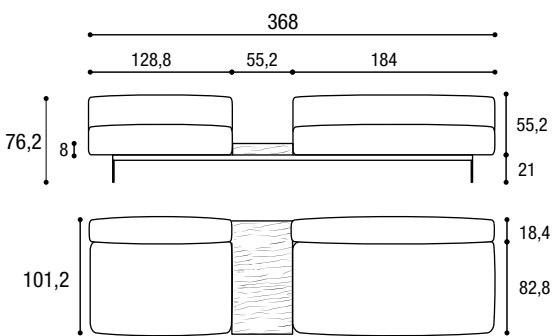
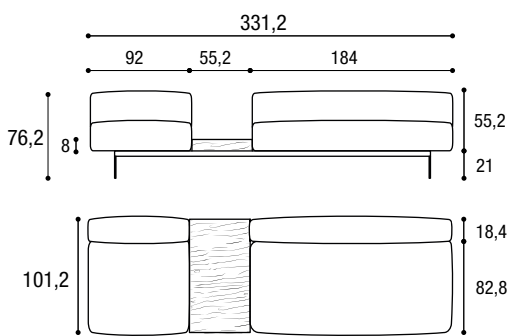
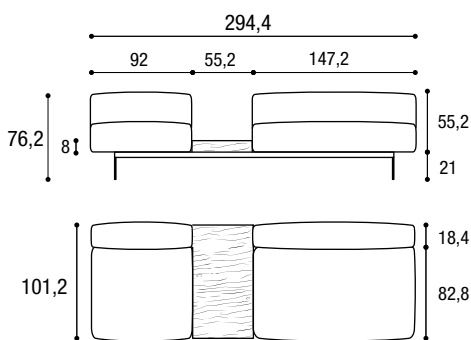
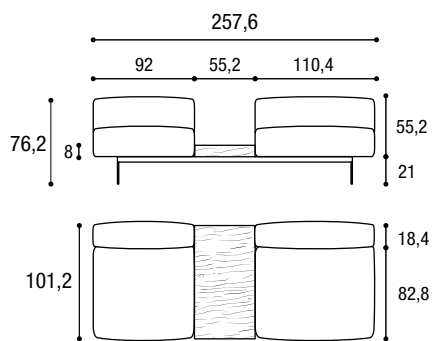

L//W	P//D	Gambe Legs	Codice Code	A	B	C	P	m	m ²
257,6	101,2	vetro glass metallo metal	ND1120					8,25	9,5
294,4	101,2	vetro glass metallo metal	ND1122					9,75	10,95
331,2	101,2	vetro glass metallo metal	ND1123					11,15	12,70
368	101,2	vetro glass metallo metal	ND1124					12,70	14,25

AIR SOFA BASI PER DIVANI//AIR SOFA BASES

Categorie **A:** Tessuto cliente.
Categories **A:** Customer's fabric.

B: Darwin. Please, Ecopelle Bloom.
B: Darwin. Please, Bloom Faux leather.

C: Francis, Axum, Barkley, Frosty, Penny, Barnum, Club.
C: Francis, Axum, Barkley, Frosty, Penny, Barnum and Club.

P: Pelle Panama.
P: Panama leather.

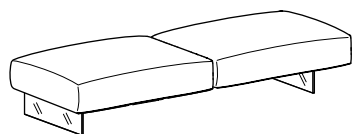

Gambe in vetro extra-chiaro o fumé grigio.
Legs in extra-clear or smoked grey glass.

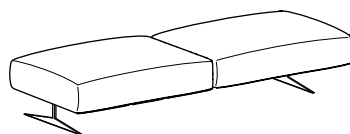

Gambe in acciaio Peltro steel o Titanio steel.
Steel legs in Peltro Steel or Titanio Steel.

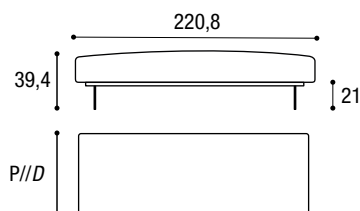
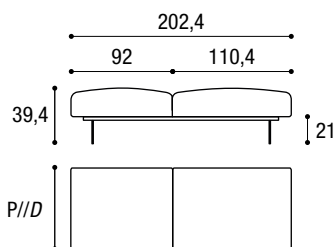
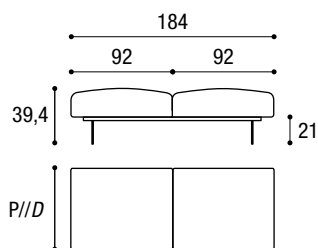
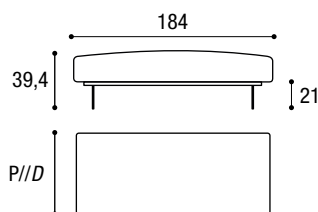
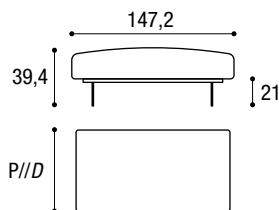

L//W	P//D	Gambe Legs	Codice Code	A	B	C	P	m	m ²
	73,6	vetro glass	ND1028					2	3
	82,8	metallo metal	ND1029					3	3,5
147,2	92	vetro glass	ND1030					3	3,5
	73,6	metallo metal	ND1037					2,4	3,75
	82,8	vetro glass	ND1038					3,7	4,4
184	92	metallo metal	ND1039					3,7	4,4
	73,6	vetro glass	ND1040					3	4
	82,8	metallo metal	ND1041					3,7	4,6
184	92	vetro glass	ND1042					3,7	4,6
	73,6	metallo metal	ND1046					3,2	4,25
	82,8	vetro glass	ND1047					4,1	5
202,4	92	metallo metal	ND1048					4,1	5
	73,6	vetro glass	ND1049					2,8	4,5
	82,8	metallo metal	ND1050					4,45	5,25
220,8	92	vetro glass	ND1051					4,45	5,25
		metallo metal							

AIR SOFA BASI PER DIVANI//AIR SOFA BASES



Categorie
Categories

A: Tessuto cliente.
A: Customer's fabric.

B: Darwin. Please, Ecopelle Bloom.
B: Darwin. Please, Bloom Faux leather.

C: Francis, Axum, Barkley, Frosty, Penny, Barnum, Club.
C: Francis, Axum, Barkley, Frosty, Penny, Barnum and Club.

P: Pelle Panama.
P: Panama leather.

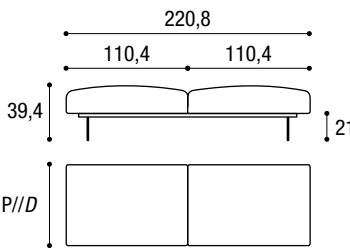
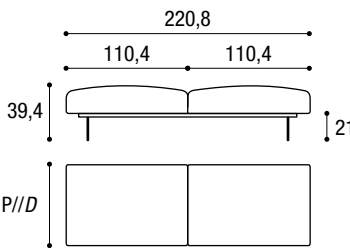
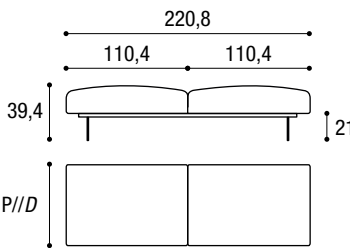
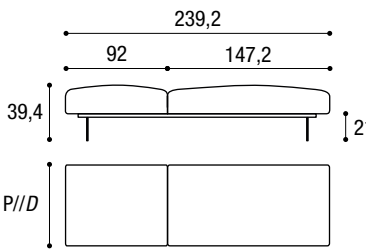
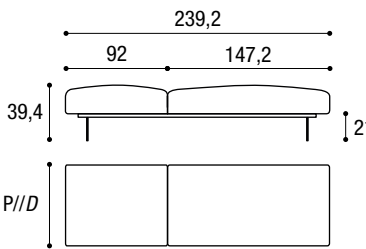
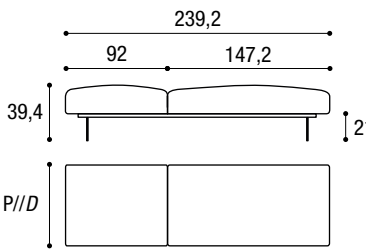
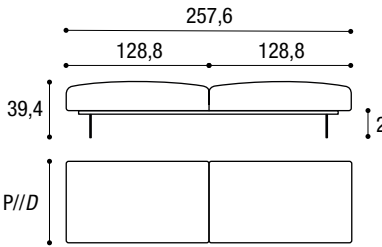
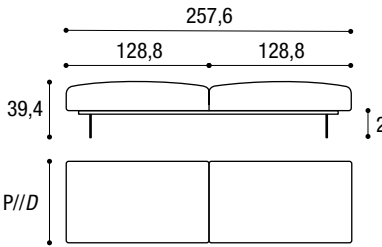
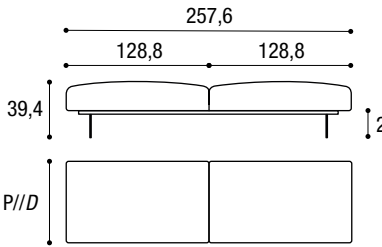
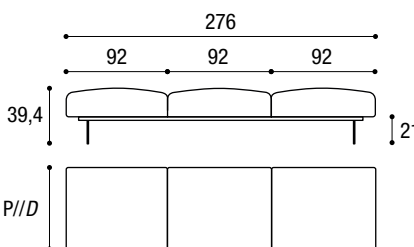
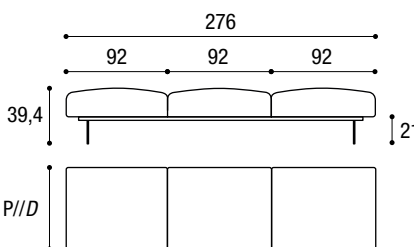
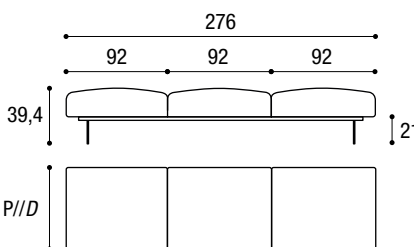
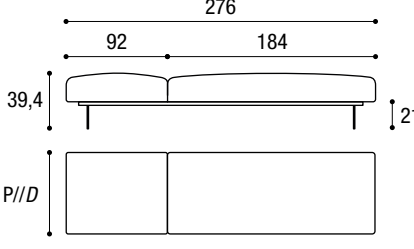
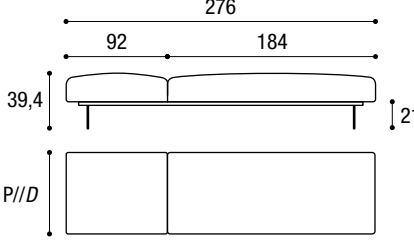
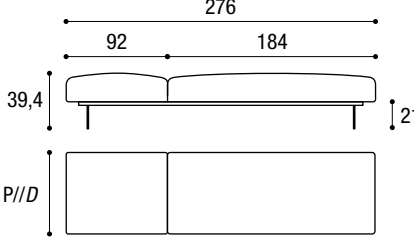
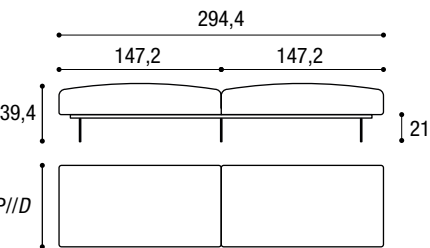
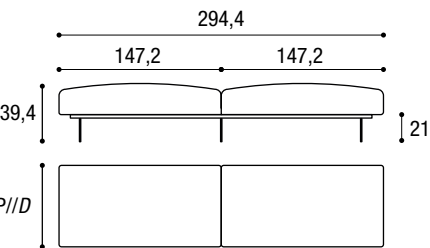
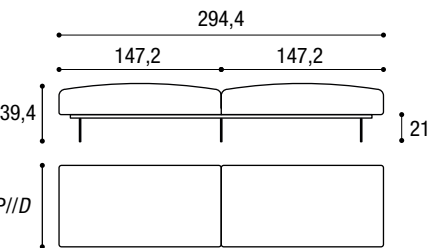
		Gambe Legs	Codice Code	A	B	C	P	 m	 m ²
	L//W								
	P//D	73,6	ND1052					3,4	4,5
			vetro glass metallo metal						
		82,8	ND1053					4,5	5,4
			vetro glass metallo metal						
		92	ND1054					4,5	5,4
									
	L//W								
	P//D	73,6	ND1061					3,5	5
			vetro glass metallo metal						
		82,8	ND1062					4,85	5,8
			vetro glass metallo metal						
		92	ND1063					4,85	5,8
									
	L//W								
	P//D	73,6	ND1064					3,7	5,4
			vetro glass metallo metal						
		82,8	ND1065					5,4	6,2
			vetro glass metallo metal						
		92	ND1066					5,4	6,2
									
	L//W								
	P//D	73,6	ND1070					4,5	6
			vetro glass metallo metal						
		82,8	ND1071					5,55	6,9
			vetro glass metallo metal						
		92	ND1072					5,55	6,9
									
	L//W								
	P//D	73,6	ND1073					3,9	5,75
			vetro glass metallo metal						
		82,8	ND1074					5,55	6,7
			vetro glass metallo metal						
		92	ND1075					5,55	6,7
									
	L//W								
	P//D	73,6	ND1076					4	6
			vetro glass metallo metal						
		82,8	ND1077					6	7
			vetro glass metallo metal						
		92	ND1078					6	7
									

Imbottitura e tessuti ignifughi disponibili su richiesta.
Fire-resistant padding and fabrics available on request.

PELLE: moduli L 147,2 e 184 cm hanno 1 cucitura. Moduli L 220,8 cm hanno 2 cuciture. 185
LEATHER: the L 147.2 and 184 cm modules have 1 seam. The L 220.8 cm modules have 2 seams.

AIR SOFA BASI PER DIVANI//AIR SOFA BASES



Categorie
Categories

A: Tessuto cliente.
A: Customer's fabric.

B: Darwin. Please, Ecopelle Bloom.
B: Darwin. Please, Bloom Faux leather.

C: Francis, Axum, Barkley, Frosty, Penny, Barnum, Club.
C: Francis, Axum, Barkley, Frosty, Penny, Barnum and Club.

P: Pelle Panama.
P: Panama leather.

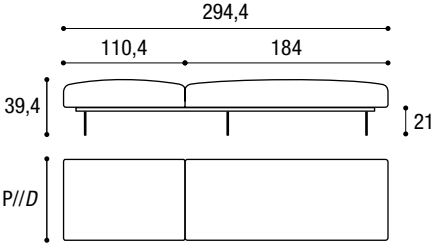
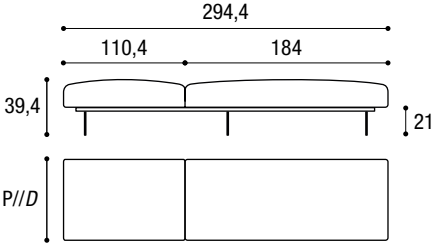
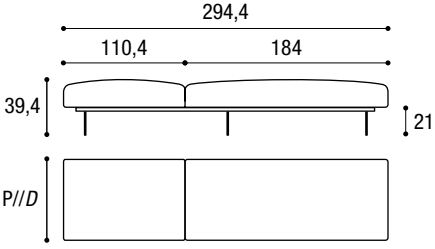
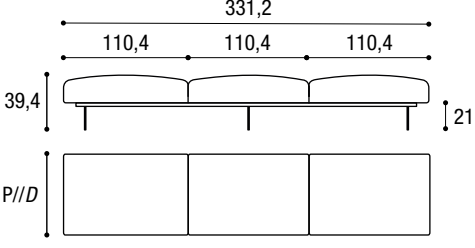
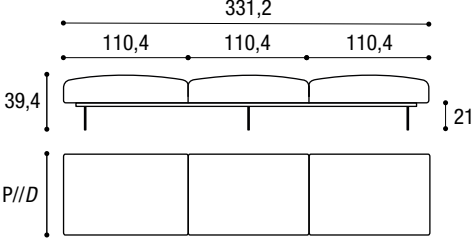
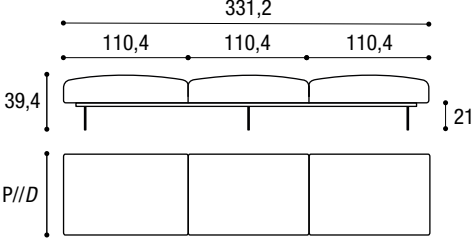
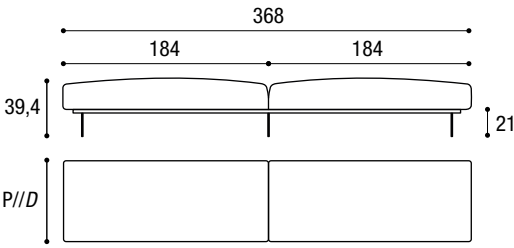
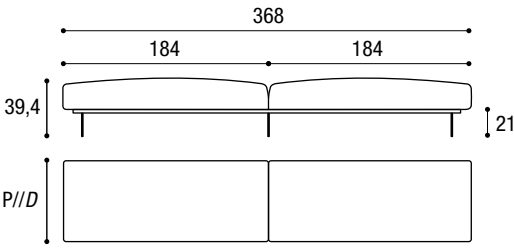
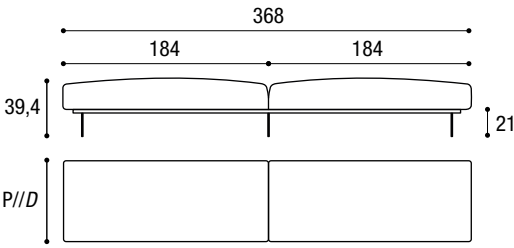
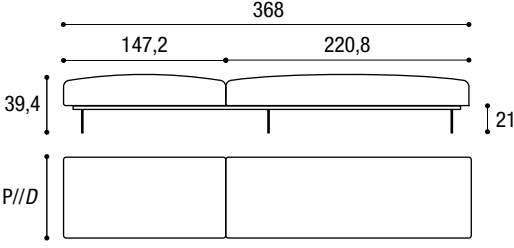
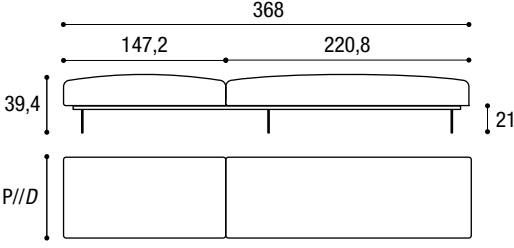
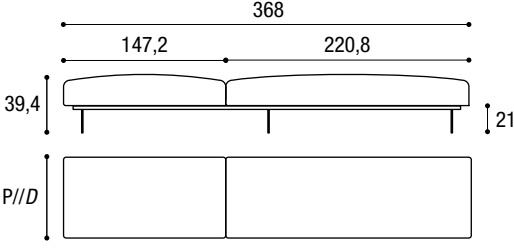
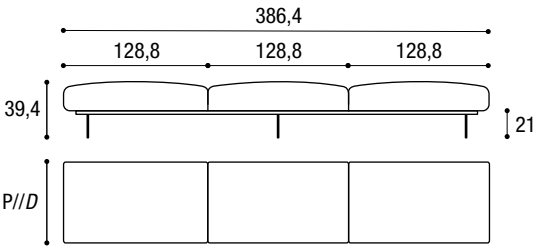
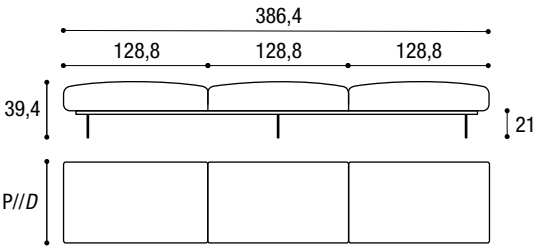
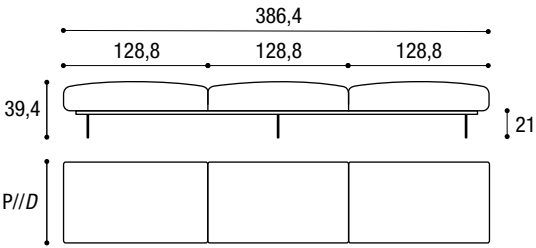
		Gambe Legs	Codice Code	A	B	C	P	 m	 m²
	L//W								
	P//D	73,6	ND1079					4,1	6
	L//W	294,4	ND1080					5,95	7,1
	P//D	82,8							
	L//W	92	ND1081					5,95	7,1
	P//D								
	L//W								
	P//D	73,6	ND1082					5,1	6,75
	L//W	331,2	ND1083					6,75	8,1
	P//D	82,8							
	L//W	92	ND1084					6,75	8,1
	P//D								
	L//W								
	P//D	73,6	ND1085					4,8	7,5
	L//W	368	ND1086					7,4	8,8
	P//D	82,8							
	L//W	92	ND1087					7,4	8,8
	P//D								
	L//W								
	P//D	73,6	ND1125						
	L//W	368	ND1126						
	P//D	82,8							
	L//W	92	ND1127						
	P//D								
	L//W								
	P//D	73,6	ND1128						
	L//W	386,4	ND1129						
	P//D	82,8							
	L//W	92	ND1130						
	P//D								

AIR SOFA BASI PER CHAISE LONGUE//AIR SOFA BASES FOR CHAISES LONGUES

Categorie **A:** Tessuto cliente.
Categories **A:** Customer's fabric.

B: Darwin. Please, Ecopelle Bloom.
B: Darwin. Please, Bloom Faux leather.

C: Francis, Axum, Barkley, Frosty, Penny, Barnum, Club.
C: Francis, Axum, Barkley, Frosty, Penny, Barnum and Club.

P: Pelle Panama.
P: Panama leather.

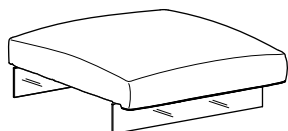

Gambe in vetro extra-chiaro o fumé grigio.
Legs in extra-clear or smoked grey glass.

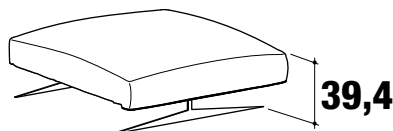

Gambe in acciaio Peltro steel o Titanio steel.
Steel legs in Peltro Steel or Titanio Steel.

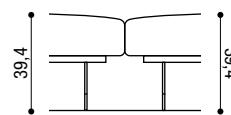

Chaise longue **Divano Sofa**

		Gambe Legs	Codice Code	A	B	C	P	m	m ²
Gambe vetro//Glass legs 	Gambe metallo//Metal legs 	L/W	P//D						
		73,6	147,2	vetro glass metallo metal	ND1088				2
		184	vetro glass metallo metal	ND1093				2,4	3,75
 	 	82,8	147,2	vetro glass metallo metal	ND1089			3	3,5
		184	vetro glass metallo metal	ND1094				3,7	4,4
 	 	92	147,2	vetro glass metallo metal	ND1090			3	3,5
		184	vetro glass metallo metal	ND1095				3,7	4,4
 	 	110,4	147,2	vetro glass metallo metal	ND1091			2,3	3,15
		184	vetro glass metallo metal	ND1096				3,7	4,7

AIR SOFA SCHIENALI E BRACCIOLI//AIR SOFA BACKRESTS AND ARMRESTS

Categorie **A:** Tessuto cliente.
Categories **A:** Customer's fabric.

B: Darwin. Please, Ecopelle Bloom.
B: Darwin. Please, Bloom Faux leather.

C: Francis, Axum, Barkley, Frosty, Penny, Barnum, Club.
C: Francis, Axum, Barkley, Frosty, Penny, Barnum and Club.

P: Pelle Panama.
P: Panama leather.

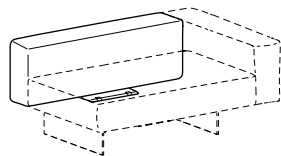

		Codice Code	A	B	C	P	m	m ²
L/W	H							
73,6	41,4	DI3104					10	1,60
		DI3204					10	1,60
		DI3404					1,50	1,70
		DI3504					1,60	1,70
82,8	41,4	DI3106					1,10	1,70
		DI3206					1,10	1,70
		DI3406					1,70	1,80
		DI3506					1,70	1,90
92	41,4	DI3107					1,20	1,90
		DI3207					1,20	1,90
		DI3407					1,90	2,0
		DI3507					1,90	2,10
101,2	41,4	DI3114					1,40	2,30
		DI3214					1,40	2,40
		DI3414					2,25	2,50
		DI3514					2,30	2,60
110,4	41,4	DI3108					1,40	2,30
		DI3208					1,40	2,40
		DI3408					2,25	2,50
		DI3508					2,30	2,60
128,8	41,4	DI3109					1,60	2,55
		DI3209					1,60	2,65
		DI3409					2,60	2,75
		DI3509					2,60	2,85
147,2	41,4	DI3110					1,80	3,5
		DI3210					1,80	3,5
		DI3410					3,0	3,15
		DI3510					3,0	3,25
184	41,4	DI3111					2,10	3,65
		DI3211					2,10	3,75
		DI3411					3,70	4,0
		DI3511					3,80	4,10
220,8	41,4	DI3112					2,50	4,50
		DI3212					2,50	4,50
		DI3412					4,50	4,85
		DI3512					4,50	4,95

AIR SOFA BRACCIOLO//AIR SOFA ARMREST

Categorie **A:** Tessuto cliente.
Categories **A:** Customer's fabric.

B: Darwin. Please, Ecopelle Bloom.
B: Darwin. Please, Bloom Faux leather.

C: Francis, Axum, Barkley, Frosty, Penny, Barnum, Club.
C: Francis, Axum, Barkley, Frosty, Penny, Barnum and Club.

P: Pelle Panama.
P: Panama leather.

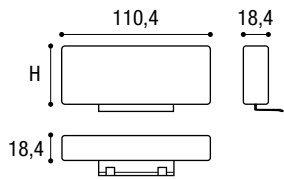
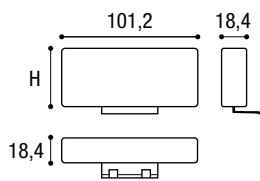
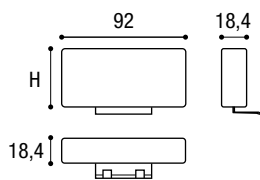
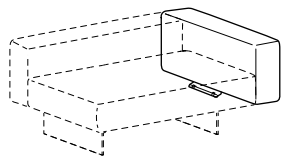

L/W	H	Codice Code	A	B	C	P	m ²	
							□	⬠
92	41,4	DI3107					1,20	1,90
	46	DI3207					1,20	1,90
	55,2	DI3407					1,90	2,0
	59,8	DI3507					1,90	2,10
101,2	41,4	DI3114					1,40	2,30
	46	DI3214					1,40	2,40
	55,2	DI3414					2,25	2,50
	59,8	DI3514					2,30	2,60
110,4	41,4	DI3108					1,40	2,30
	46	DI3208					1,40	2,40
	55,2	DI3408					2,25	2,50
	59,8	DI3508					2,30	2,60





AIR SOFA - CUSCINI INTERNO FIBRA ANALLERGICA//CUSHIONS FILLED WITH HYPOALLERGENIC FIBRES

Categorie **A:** Tessuto cliente.
Categories **A:** Customer's fabric.

B: Darwin. Please, Ecopelle Bloom.
B: Darwin. Please, Bloom Faux leather.

C: Francis, Axum, Barkley, Frosty, Penny, Barnum, Club.
C: Francis, Axum, Barkley, Frosty, Penny, Barnum and Club.

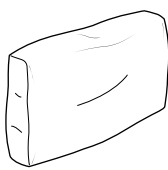
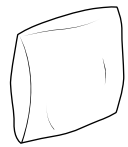
P: Pelle Panama.
P: Panama leather.

		Codice Code	A	B	C	P	 m	 m²
L/W	H							
Cuscino con fascia <i>Cushion with panel</i>								
								
55,2	50,6	DI5185					0,70	10
73,6	50,6	DI5186					0,90	1,40
Cuscino a saponetta quadrata <i>Square soap-shaped cushion</i>								
								
36,8	36,8	DI5171					0,40	0,60
46	46	DI5172					0,50	0,80
Cuscino a saponetta lombare <i>Back-support soap-shaped cushion</i>								
								
55,2	32,2	DI5175					0,60	0,70

Imbottitura e tessuti ignifughi disponibili su richiesta.
Fire-resistant padding and fabrics available on request.





AIR SOFA - CUSCINI INTERNO PIUMA D'OCA//CUSHIONS FILLED WITH GOOSE FEATHERS

Categorie **A:** Tessuto cliente.
Categories **A:** Customer's fabric.

B: Darwin. Please, Ecopelle Bloom.
B: Darwin. Please, Bloom Faux leather.

C: Francis, Axum, Barkley, Frosty, Penny, Barnum, Club.
C: Francis, Axum, Barkley, Frosty, Penny, Barnum and Club.

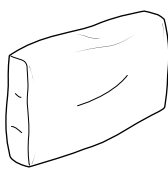
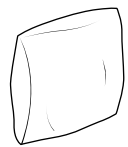
P: Pelle Panama.
P: Panama leather.

		Codice Code	A	B	C	P	 m	 m²
L/W	H							
Cuscino con fascia <i>Cushion with panel</i>								
								
55,2	50,6	DI5085					0,70	10
73,6	50,6	DI5086					0,90	1,40
Cuscino a saponetta quadrata <i>Square soap-shaped cushion</i>								
								
36,8	36,8	DI5071					0,40	0,60
46	46	DI5072					0,50	0,80
Cuscino a saponetta lombare <i>Back-support soap-shaped cushion</i>								
								
55,2	32,2	DI5075					0,60	0,70

AIR SOFA POUF//AIR SOFA POUF

Categorie **A:** Tessuto cliente.
Categories **A:** Customer's fabric.

B: Darwin. Please, Ecopelle Bloom.
B: Darwin. Please, Bloom Faux leather.

C: Francis, Axum, Barkley, Frosty, Penny, Barnum, Club.
C: Francis, Axum, Barkley, Frosty, Penny, Barnum and Club.

P: Pelle Panama.
P: Panama leather.

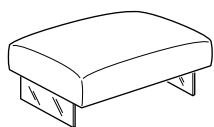

Gambe in vetro extra-chiaro o fumé grigio.
Legs in extra-clear or smoked grey glass.

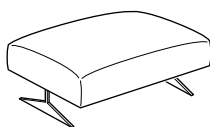

Gambe in acciaio Peltro steel o Titanio steel.
Steel legs in Peltro Steel or Titanio Steel.



Non è possibile agganciare schienali e braccioli.
Backrests and armrests cannot be docked.

		Gambe Legs	Codice Code	A	B	C	P	m	m ²
L//W	P//D								
		vetro glass	DI535					1,1	1,4
		vetro glass	DI536					1,2	1,9
		vetro glass metallo metal	DI531					1,3	1,7
		vetro glass metallo metal	DI532					1,5	2,3

AIR SOFA TELAIO//AIR SOFA FRAME

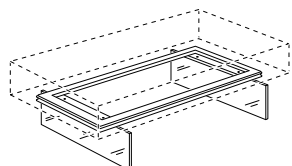

Gambe in vetro extra-chiaro o fumé grigio.
Legs in extra-clear or smoked grey glass.

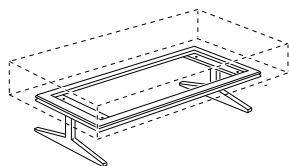

Gambe in acciaio Peltro steel o Titanio steel.
Steel legs in Peltro Steel or Titanio Steel.

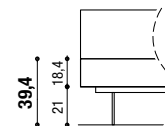
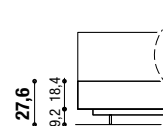

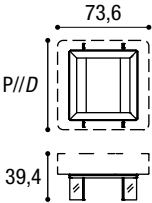
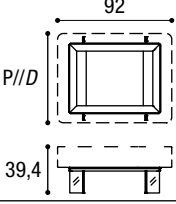
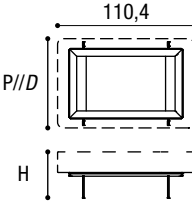
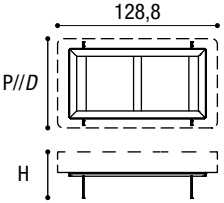
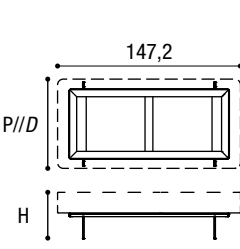
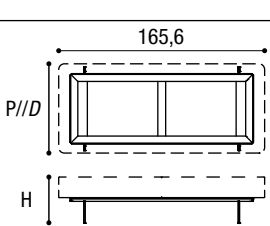
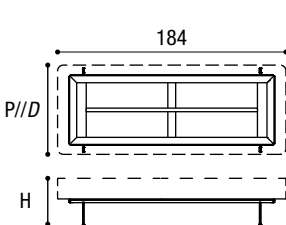
		Gambe Legs	H 27,6	H 39,4
L/W	P//D			
	73,6	73,6 vetro//glass	—	DT0122
		82,8 vetro//glass	—	DT0123
	92	73,6 vetro//glass	—	DT0222
		82,8 metallo//metal	—	DT0223
	110,4	73,6 vetro//glass	DT0312	DT0322
		82,8 metallo//metal	DT0313	DT0323
		92 vetro//glass	DT0314	DT0324
		110,4 metallo//metal	DT0315	DT0325
	128,8	73,6 vetro//glass	DT0412	DT0422
		82,8 metallo//metal	DT0413	DT0423
		92 vetro//glass	DT0414	DT0424
	147,2	73,6 vetro//glass	DT0512	DT0522
		82,8 metallo//metal	DT0513	DT0523
		92 vetro//glass	DT0514	DT0524
		110,4 metallo//metal	DT0515	DT0525
		128,8 vetro//glass	DT0516	DT0526
	165,6	73,6 vetro//glass	DT0612	DT0622
		82,8 metallo//metal	DT0613	DT0623
		92 vetro//glass	DT0614	DT0624
	184	73,6 vetro//glass	DT0712	DT0722
		82,8 metallo//metal	DT0713	DT0723
		92 vetro//glass	DT0714	DT0724
		110,4 metallo//metal	DT0715	DT0725

AIR SOFA TELAIO//AIR SOFA FRAME

				Gambe Legs	H 27,6	H 39,4
	L/W	P//D	202,4	73,6	vetro//glass	DT0812
				82,8	metallo//metal	DT0813
				92	metallo//metal	DT0814
	L/W	P//D	220,8	73,6	vetro//glass	DT0912
				82,8	metallo//metal	DT0913
				92	metallo//metal	DT0914
	L/W	P//D	239,2	73,6	vetro//glass	—
				82,8	metallo//metal	DT1023
				92	metallo//metal	DT1024
	L/W	P//D	257,6	73,6	vetro//glass	—
				82,8	metallo//metal	DT1123
				92	metallo//metal	DT1124
	L/W	P//D	276	73,6	vetro//glass	—
				82,8	metallo//metal	DT1223
				92	metallo//metal	DT1224
	L/W	P//D	294,4	73,6	vetro//glass	—
				82,8	metallo//metal	DT1323
				92	metallo//metal	DT1324
	L/W	P//D	312,8	73,6	vetro//glass	—
				82,8	metallo//metal	DT1423
				92	metallo//metal	DT1424
	L/W	P//D	331,2	73,6	vetro//glass	—
				82,8	metallo//metal	DT1523
				92	metallo//metal	DT1524
	L/W	P//D	349,6	73,6	vetro//glass	—
				82,8	metallo//metal	DT1623
				92	metallo//metal	DT1624
	L/W	P//D	368	73,6	vetro//glass	—
				82,8	metallo//metal	DT1723
				92	metallo//metal	DT1724

AIR SOFA SEDUTE//AIR SOFA SEATS

Categorie
Categories

A: Tessuto cliente.
A: Customer's fabric.

B: Darwin. Please, Ecopelle Bloom.
B: Darwin. Please, Bloom Faux leather.

C: Francis, Axum, Barkley, Frosty, Penny, Barnum, Club.
C: Francis, Axum, Barkley, Frosty, Penny, Barnum and Club.

P: Pelle Panama.
P: Panama leather.

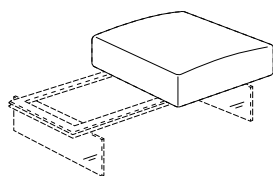

Gambe in vetro extra-chiaro o fumé grigio.
Legs in extra-clear or smoked grey glass.

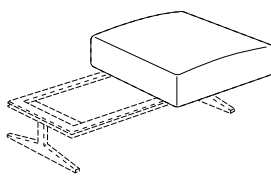

Gambe in acciaio Peltro steel o Titanio steel.
Steel legs in Peltro Steel or Titanio Steel.

		Codice Code	A	B	C	P	m	m ²
L//W	P//D							
 73,6 18,4 P//D	73,6 73,6 82,8 92	DI1132					1,30	1,70
		DI1172					1,50	20
		DI1142					1,50	20
 92 18,4 P//D	92 73,6 82,8 92	DI1133					1,50	20
		DI1173					1,85	2,30
		DI1143					1,85	2,30
 110,4 18,4 P//D	110,4 73,6 82,8 92 110,4	DI1134					1,70	2,25
		DI1174					2,25	2,70
		DI1144					2,25	2,70
		DI1154					1,80	2,75
 128,8 18,4 P//D	128,8 73,6 82,8 92	DI1138					1,85	2,7
		DI1178					2,7	3,1
		DI1148					2,7	3,1
 147,2 18,4 P//D	147,2 73,6 82,8 92 110,4 128,8	DI1135					20	30
		DI1175					30	3,50
		DI1145					30	3,50
		DI1155						
		DI1165					2,20	3,50
 184 18,4 P//D	184 73,6 82,8 92	DI1136					2,40	3,75
		DI1176					3,70	4,40
		DI1146					3,70	4,40
 220,8 18,4 P//D	220,8 73,6 82,8 92	DI1137					2,80	4,50
		DI1177					4,45	5,25
		DI1147					4,45	5,25

AIR SOFA PENISOLE//AIR CHAISE SOFAS

Categorie **A:** Tessuto cliente.
Categories **A:** Customer's fabric.

B: Darwin. Please, Ecopelle Bloom.
B: Darwin. Please, Bloom Faux leather.

C: Francis, Axum, Barkley, Frosty, Penny, Barnum, Club.
C: Francis, Axum, Barkley, Frosty, Penny, Barnum and Club.

P: Pelle Panama.
P: Panama leather.

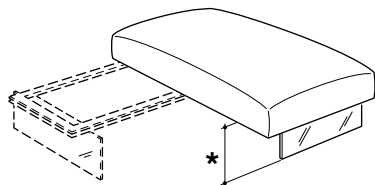

Gambe in vetro extra-chiaro o fumé grigio.
Legs in extra-clear or smoked grey glass.

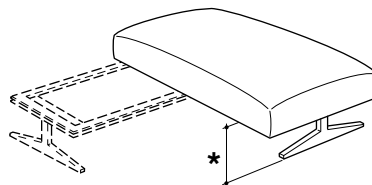

Gambe in acciaio Peltro steel o Titanio steel.
Steel legs in Peltro Steel or Titanio Steel.

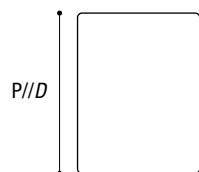
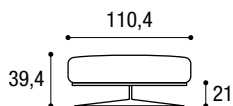
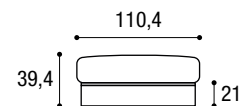
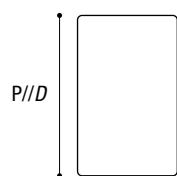
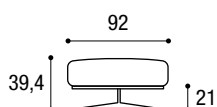
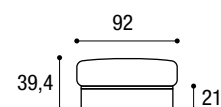
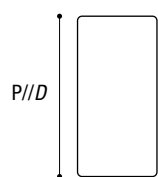
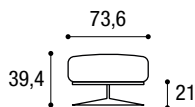
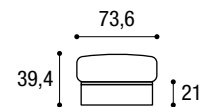

L//W	P//D	Gambe Legs	Codice Code	A	B	C	P	□ m	◊ m ²
73,6	147,2	vetro glass metallo metal	DI6101					2	3
	184	vetro glass metallo metal	DI6102					2,4	3,75
92	147,2	vetro glass metallo metal	DI6301					3	3,5
	184	vetro glass metallo metal	DI6302					3,7	4,4
110,4	147,2	vetro glass metallo metal	DI6401					3	45
	184	vetro glass metallo metal	DI6402					3,7	55

* Le penisole sono fornite complete di supporto, l'altezza è determinata dal telaio.
* The peninsulas are supplied with a support, the height is determined by the frame.

Imbottitura e tessuti ignifughi disponibili su richiesta.
Fire-resistant padding and fabrics available on request.

AIR SOFA SCHIENALI E BRACCIOLI//AIR SOFA BACKRESTS AND ARMRESTS

Categorie
Categories

A: Tessuto cliente.
A: Customer's fabric.

B: Darwin. Please, Ecopelle Bloom.
B: Darwin. Please, Bloom Faux leather.

C: Francis, Axum, Barkley, Frosty, Penny, Barnum, Club.
C: Francis, Axum, Barkley, Frosty, Penny, Barnum and Club.

P: Pelle Panama.
P: Panama leather.

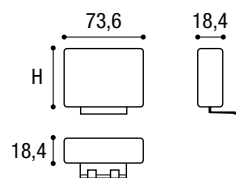
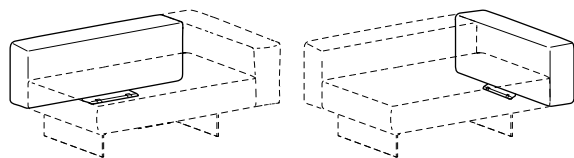

		Codice Code	A	B	C	P	m	m ²
L/W	H							
73,6	41,4	DI3104					10	1,60
	46	DI3204					10	1,60
	55,2	DI3404					1,50	1,70
	59,8	DI3504					1,60	1,70
82,8	41,4	DI3106					1,10	1,70
	46	DI3206					1,10	1,70
	55,2	DI3406					1,70	1,80
	59,8	DI3506					1,70	1,90
92	41,4	DI3107					1,20	1,90
	46	DI3207					1,20	1,90
	55,2	DI3407					1,90	20
	59,8	DI3507					1,90	2,10
101,2	41,4	DI3114					1,40	2,30
	46	DI3214					1,40	2,40
	55,2	DI3414					2,25	2,50
	59,8	DI3514					2,30	2,60
110,4	41,4	DI3108					1,40	2,30
	46	DI3208					1,40	2,40
	55,2	DI3408					2,25	2,50
	59,8	DI3508					2,30	2,60
128,8	41,4	DI3109					1,60	2,55
	46	DI3209					1,60	2,65
	55,2	DI3409					2,60	2,75
	59,8	DI3509					2,60	2,85
147,2	41,4	DI3110					1,80	35
	46	DI3210					1,80	35
	55,2	DI3410					30	3,15
	59,8	DI3510					30	3,25
184	41,4	DI3111					2,10	3,65
	46	DI3211					2,10	3,75
	55,2	DI3411					3,70	40
	59,8	DI3511					3,80	4,10
220,8	41,4	DI3112					2,50	4,50
	46	DI3212					2,50	4,50
	55,2	DI3412					4,50	4,85
	59,8	DI3512					4,50	4,95

AIR SOFA - CUSCINI INTERNO FIBRA ANALLERGICA//CUSHIONS FILLED WITH HYPOALLERGENIC FIBRES





Categorie
Categories

A: Tessuto cliente.
A: Customer's fabric.

B: Darwin. Please, Ecopelle Bloom.
B: Darwin. Please, Bloom Faux leather.

C: Francis, Axum, Barkley, Frosty, Penny, Barnum, Club.
C: Francis, Axum, Barkley, Frosty, Penny, Barnum and Club.

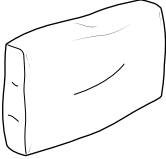
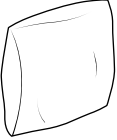
P: Pelle Panama.
P: Panama leather.

	L/W	H	Codice Code	A	B	C	P	 m	 m ²
Cuscino con fascia <i>Cushion with panel</i> 	55,2	50,6	DI5185					0,70	10
			DI5186					0,90	1,40
	73,6	50,6							
Cuscino a saponetta quadrata <i>Square soap-shaped cushion</i> 	36,8	36,8	DI5171					0,40	0,60
			DI5172					0,50	0,80
	46	46							
Cuscino a saponetta lombare <i>Back-support soap-shaped cushion</i> 	55,2	32,2	DI5175					0,60	0,70

Imbottitura e tessuti ignifughi disponibili su richiesta.
Fire-resistant padding and fabrics available on request.

AIR SOFA - CUSCINI INTERNO PIUMA D'OCA//CUSHIONS FILLED WITH GOOSE FEATHERS





Categorie
Categories

A: Tessuto cliente.
A: Customer's fabric.

B: Darwin. Please, Ecopelle Bloom.
B: Darwin. Please, Bloom Faux leather.

C: Francis, Axum, Barkley, Frosty, Penny, Barnum, Club.
C: Francis, Axum, Barkley, Frosty, Penny, Barnum and Club.

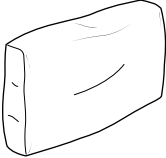
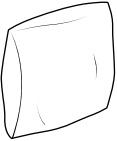
P: Pelle Panama.
P: Panama leather.

	L/W	H	Codice Code	A	B	C	P	 m	 m ²
Cuscino con fascia <i>Cushion with panel</i> 	55,2	50,6	DI5085					0,70	10
			DI5086					0,90	1,40
	73,6	50,6							
Cuscino a saponetta quadrata <i>Square soap-shaped cushion</i> 	36,8	36,8	DI5071					0,40	0,60
			DI5072					0,50	0,80
	46	46							
Cuscino a saponetta lombare <i>Back-support soap-shaped cushion</i> 	55,2	32,2	DI5075					0,60	0,70

AIR SOFA - ESEMPI DI COMPOSIZIONE//COMPOSITION EXAMPLES

Categorie **A:** Tessuto cliente. **B:** Darwin. Please, Ecopelle Bloom. **C:** Francis, Axum, Barkley, Frosty, Penny, Barnum, Club. **P:** Pelle Panama.
 Categories **A:** Customer's fabric. **B:** Darwin. Please, Bloom Faux leather. **C:** Francis, Axum, Barkley, Frosty, Penny, Barnum, Club. **P:** Panama leather.

2705

Altezza schienali 55,2
Back height 55,2

Altezza braccioli 41,4
Armrest height 41,4

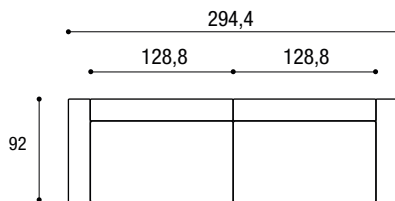

Composizione Composition	Larghezza Width	Profondità Depth	Altezza Height	Codice Code	A	B	C	P
2705	294,4	92	76,2	270501				
Cuscino con fascia//Cushion with panel n°3 (prezzo cad./price each.)	55,2	18	50,6	DI5085				

2706

Altezza schienali 55,2
Back height 55,2

Altezza braccioli 41,4
Armrest height 41,4

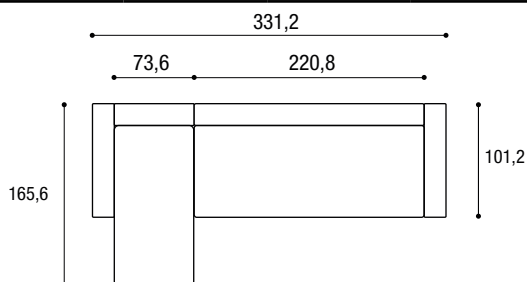

Composizione Composition	Larghezza Width	Profondità Depth	Altezza Height	Codice Code	A	B	C	P
2706	331,2	165,6	76,2	270601				
Cuscino con fascia//Cushion with panel n°3 (prezzo cad./price each.)	55,2	18	50,6	DI5085				

2707

Altezza schienali 55,2
Back height 55,2

Altezza braccioli 41,4
Armrest height 41,4

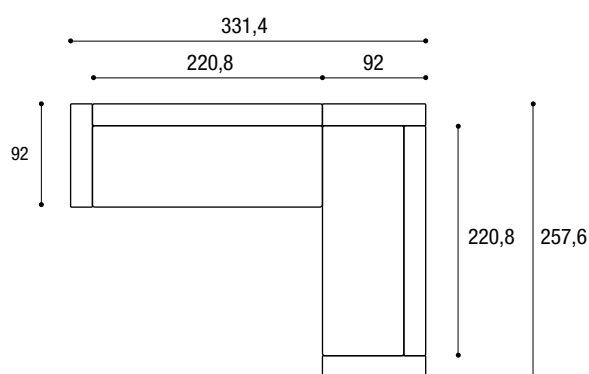

Composizione Composition	Larghezza Width	Profondità Depth	Altezza Height	Codice Code	A	B	C	P
2707	331,4	257,6	76,2	270701				
Cuscino con fascia//Cushion with panel n°4 (prezzo cad./price each.)	73,6	18	50,6	DI5186				

2686*

Altezza schienali 55,2
Back height 55,2

Altezza braccioli 41,4
Armrest height 41,4

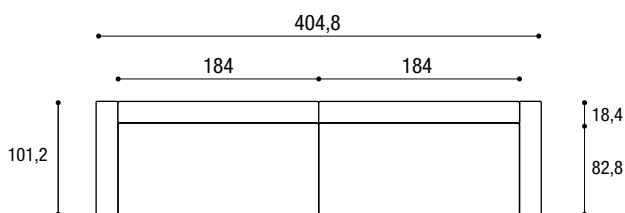

Composizione Composition	Larghezza Width	Profondità Depth	Altezza Height	Codice Code	A	B	C	P
2686	404,8	101,2	76,2	268601				
Cuscino con fascia//Cushion with panel n°3 (prezzo cad./price each.)	73,6	18	50,6	DI5186				
Cuscini a saponetta quadrata Square soap-shaped cushions	36,8	12	36,8	DI5071				

AIR SOFA - ESEMPI DI COMPOSIZIONE//COMPOSITION EXAMPLES

Categorie **A:** Tessuto cliente. **B:** Darwin. Please, Ecopelle Bloom. **C:** Francis, Axum, Barkley, Frosty, Penny, Barnum, Club. **P:** Pelle Panama.
 Categories **A:** Customer's fabric. **B:** Darwin. Please, Bloom Faux leather. **C:** Francis, Axum, Barkley, Frosty, Penny, Barnum, Club. **P:** Panama leather.

0819*

Altezza schienali 55,2
Back height 55,2

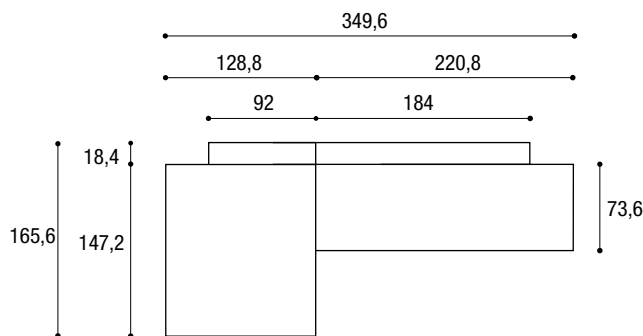

Composizione Composition	Larghezza Width	Profondità Depth	Altezza Height	Codice Code	A	B	C	P
0819	349,6	165,6	76,2	081901				
Cuscino con fascia//Cushion with panel n°2 (prezzo cad./price each.)	73,6	18	50,6	DI5186				
Cuscino a saponetta quadrata//Square soap-shaped cushion n°4 (prezzo cad./price each.)	36,8	12	36,8	DI5071				
Cuscino a saponetta quadrata//Square soap-shaped cushion n°1 (prezzo cad./price each.)	46	12	46	DI5072				
Cuscino a saponetta lombare//Back-support soap-shaped cushion n°1 (prezzo cad./price each.)	55,2	12	32,2	DI5075				

0818*

Altezza schienali 55,2 e 46
Back height 55,2 and 46

Altezza braccioli 46 e 41,4
Armrest height 46 and 41,4

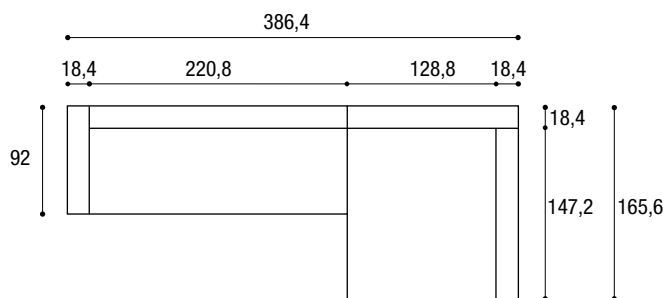

Composizione Composition	Larghezza Width	Profondità Depth	Altezza Height	Codice Code	A	B	C	P
0818	386,4	165,6	76,2	081801				
Cuscino con fascia//Cushion with panel n°2 (prezzo cad./price each.)	73,6	18	50,6	DI5186				
Cuscino a saponetta quadrata//Square soap-shaped cushion n°6 (prezzo cad./price each.)	36,8	12	36,8	DI5071				
Cuscino a saponetta quadrata//Square soap-shaped cushion n°2 (prezzo cad./price each.)	46	12	46	DI5072				
Cuscino a saponetta lombare//Back-support soap-shaped cushion n°1 (prezzo cad./price each.)	55,2	12	32,2	DI5075				

2687*

Altezza schienali 46
Back height 46

Altezza braccioli 46
Armrest height 46

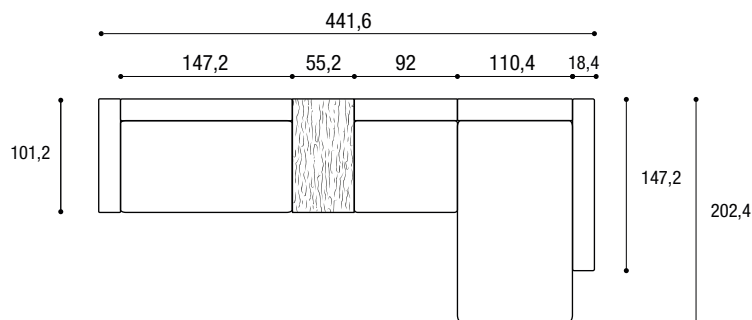

Composizione Composition	Larghezza Width	Profondità Depth	Altezza Height	Codice Code	A	B	C	P
2687	441,6	202,4	67	268701				
Cuscino con fascia//Cushion with panel n°4 (prezzo cad./price each.)	55,2	18	50,6	DI5085				
Cuscino a saponetta quadrata//Square soap-shaped cushion	46	12	46	DI5072				

Prezzi calcolati con telaio con sostegni in vetro, salvo dove specificato.
Prices calculated with frame with glass supports, unless specified otherwise.

* Composizione a catalogo
* Catalogue composition

199

AIR SOFA - ESEMPI DI COMPOSIZIONE//COMPOSITION EXAMPLES

Categorie **A:** Tessuto cliente. **B:** Darwin. Please, Ecopelle Bloom. **C:** Francis, Axum, Barkley, Frosty, Penny, Barnum, Club. **P:** Pelle Panama.
 Categories **A:** Customer's fabric. **B:** Darwin. Please, Bloom Faux leather. **C:** Francis, Axum, Barkley, Frosty, Penny, Barnum, Club. **P:** Panama leather.

2737*

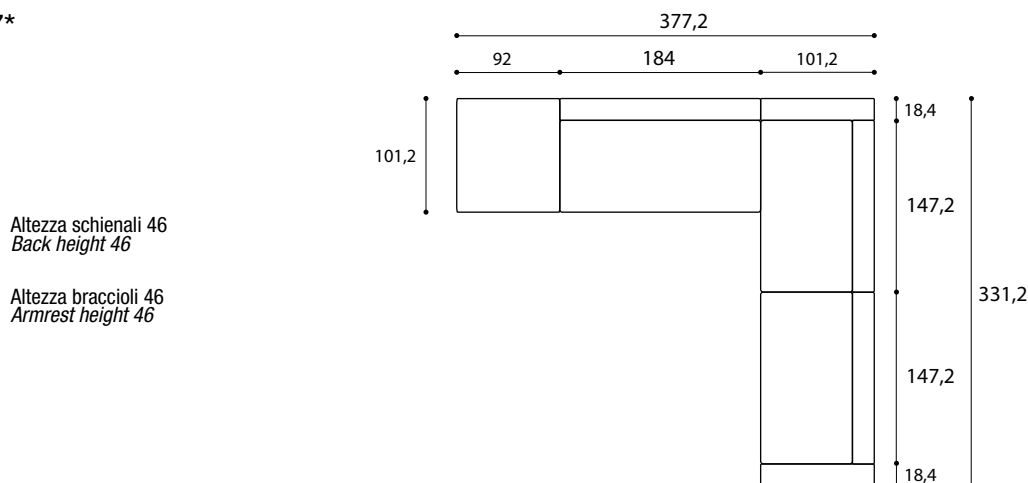

Composizione Composition	Larghezza Width	Profondità Depth	Altezza Height	Codice Code	A	B	C	P
2737	377,2	331,2	67	268801				
Cuscino con fascia//Cushion with panel n°5 (prezzo cad./price each.)	73,6	18	50,6	DI5086				
Cuscino a saponetta quadrata//Square soap-shaped cushion n°2 (prezzo cad./price each.)	46	12	46	DI5072				

2736*

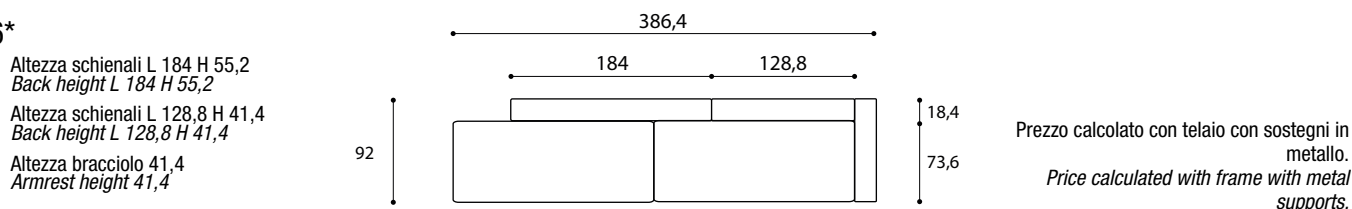

Composizione Composition	Larghezza Width	Profondità Depth	Altezza Height	Codice Code	A	B	C	P
2736	386,4	92	76,2	273601				
Cuscino con fascia//Cushion with panel n°3 (prezzo cad./price each.)	73,6	18	50,6	DI5186				
Cuscino a saponetta quadrata//Square soap-shaped cushion n°1 (prezzo cad./price each.)	36,8	12	36,8	DI5071				
Cuscino a saponetta lombare//Back-support soap-shaped cushion n°1 (prezzo cad./price each.)	55,2	12	32,2	DI5075				

2717*



Composizione Composition	Larghezza Width	Profondità Depth	Altezza Height	Codice Code	A	B	C	P
2717	147,2	92	67	271701				
Cuscino con fascia//Cushion with panel	73,6	18	50,6	DI5086				
Cuscino a saponetta quadrata//Square soap-shaped cushion	36,8	12	36,8	DI5071				

2718*



Composizione Composition	Larghezza Width	Profondità Depth	Altezza Height	Codice Code	A	B	C	P
2718	92	101,2	76,2	271801				
Cuscino con fascia//Cushion with panel n°4 (prezzo cad./price each.)	55,2	18	50,6	DI5085				
Cuscino a saponetta quadrata//Square soap-shaped cushion	36,8	12	36,8	DI5071				

AIR SOFA - ESEMPI DI COMPOSIZIONE//COMPOSITION EXAMPLES

Categorie **A:** Tessuto cliente. **B:** Darwin. Please, Ecopelle Bloom. **C:** Francis, Axum, Barkley, Frosty, Penny, Barnum, Club. **P:** Pelle Panama.
 Categories **A:** Customer's fabric. **B:** Darwin. Please, Bloom Faux leather. **C:** Francis, Axum, Barkley, Frosty, Penny, Barnum, Club. **P:** Panama leather.

2719*

Altezza schienali 55,2
Back height 55,2

Altezza bracciolo 41,4
Armrest height 41,4

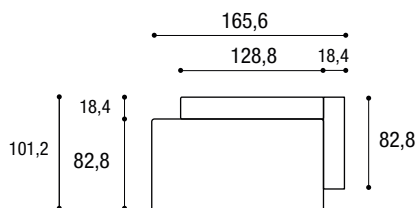

Composizione Composition	Larghezza Width	Profondità Depth	Altezza Height	Codice Code	A	B	C	P
2719	165,6	101,2	76,2	271901				
Cuscino con fascia//Cushion with panel	73,6	18	50,6	D15086				
Cuscino a saponetta quadrata//Square soap-shaped cushion	36,8	12	36,8	D15071				

Prezzi calcolati con telaio con sostegni in vetro, salvo dove specificato.
Prices calculated with frame with glass supports, unless specified otherwise.

* Composizione a catalogo
* Catalogue composition

RICAMBIO TESSUTO SEDUTE//FABRIC CHANGE FOR SEATS

Larghezza Width	Profondità Depth	Codice Code	Ricambio A Change A	Ricambio B Change B	Ricambio C Change C	Ricambio P Change P
73,6	73,6	D21132				
	82,8	D21172				
	92	D21142				
92	73,6	D21133				
	82,8	D21173				
	92	D21143				
	101,2	D21153				
110,4	73,6	D21134				
	82,8	D21174				
	92	D21144				
	110,4	D21154				
128,8	73,6	D21138				
	82,8	D21178				
	92	D21148				
147,2	73,6	D21135				
	82,8	D21175				
	92	D21145				
184	73,6	D21136				
	82,8	D21176				
	92	D21146				
220,8	73,6	D21137				
	82,8	D21177				
	92	D21147				

RICAMBIO TESSUTO PENISOLE//FABRIC CHANGE FOR PENINSULAS

Larghezza Width	Profondità Depth	Codice Code	Ricambio A Change A	Ricambio B Change B	Ricambio C Change C	Ricambio P Change P
73,6	147,2	D22130				
	184	D22140				
92	147,2	D22131				
	184	D22141				
110,4	147,2	D22132				
	184	D22142				

RICAMBIO TESSUTO POUF//FABRIC CHANGE FOR POUFS

Larghezza Width	Profondità Depth	Codice Code	Ricambio A Change A	Ricambio B Change B	Ricambio C Change C	Ricambio P Change P
73,6	55,2	D21131				
	73,6	D21132				
92	92	D21143				
110,4	55,2	D21151				