

1351 / S •

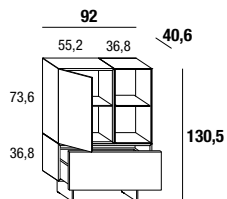
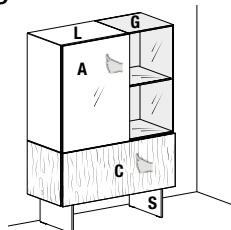

Indicare:

A- colore frontale;
 C- unico colore per struttura Rovere Gentile e frontali Wildwood;
 L- colore struttura laccata;
 G- finitura struttura vetro: extra-chiaro, fumè grigio o fumè bronzo;
 S- finitura sostegni: vetro: extra-chiaro o fumè grigio, metallo: Peltro steel o Titanio steel
Optional: illuminazione LED sul retro.

Please specify:

A- front colour;
 C- one colour for Gentle oak structure and Wildwood fronts;
 L- lacquered structure colour;
 G- glass structure finish: Extra-chiaro, Smoked Grey or Smoked Bronze;
 S- support finish: glass: Extra-chiaro or Smoked Grey, metal: Peltro Steel or Titanio Steel
Optional: LED lighting on the reverse.

					Frontale A//A front				
	L/W	P/D	A/H	Codice Code	Laccato Lacquered	Vetro lucido Polished glass	Vetro opaco Matt glass	XGlass lucido o opaco Polished or matt XGlass	Wildwood
Ⓢ	92	40,6	130,5	135101					

1351 / D •

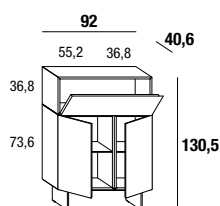
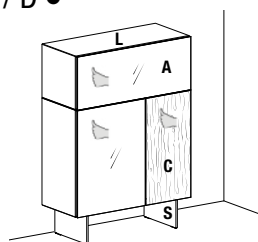

Indicare:

A- colore frontale;
 C- unico colore per struttura Rovere Gentile e frontali Wildwood;
 L- colore struttura laccata;
 S- finitura sostegni: vetro: extra-chiaro o fumè grigio, metallo: Peltro steel o Titanio steel
Optional: illuminazione LED sul retro, illuminazione LED sottobase.

Please specify:

A- front colour;
 C- one colour for Gentle oak structure and Wildwood fronts;
 L- lacquered structure colour;
 S- support finish: glass: Extra-chiaro or Smoked Grey, metal: Peltro Steel or Titanio Steel
Optional: LED lighting on the reverse, LED lighting under base.

					Frontale A//A front				
	L/W	P/D	A/H	Codice Code	Laccato Lacquered	Vetro lucido Polished glass	Vetro opaco Matt glass	XGlass lucido o opaco Polished or matt XGlass	Wildwood
Ⓢ	92	40,6	130,5	135102					

1352 •

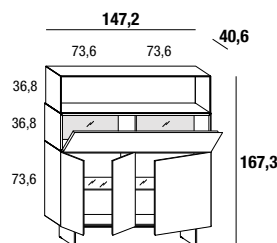
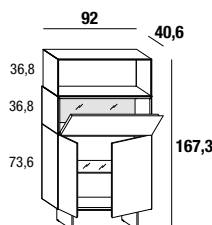
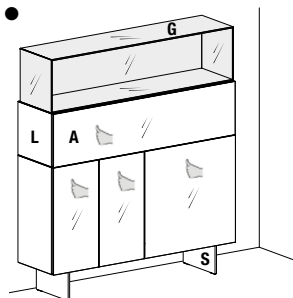

Indicare:

A- colore frontale;
 L- colore struttura laccata;
 G- finitura struttura vetro: extra-chiaro, fumè grigio o fumè bronzo;
 S- finitura sostegni: vetro: extra-chiaro o fumè grigio, metallo: Peltro steel o Titanio steel
 Interno con schiena in specchio fumè bronzo.
Optional: illuminazione LED sul retro. illuminazione LED sottobase.

Please specify:

A- front colour;
 L- lacquered structure colour;
 G- glass structure finish: Extra-chiaro, Smoked Grey or Smoked Bronze;
 S- support finish: glass: Extra-chiaro or Smoked Grey, metal: Peltro Steel or Titanio Steel
 Inside back in Smoked Bronze mirror.
Optional: LED lighting on the reverse, LED lighting under base.

					Frontale A//A front				
	L/W	P/D	A/H	Codice Code	Laccato Lacquered	Vetro lucido Polished glass	Vetro opaco Matt glass	XGlass lucido o opaco Polished or matt XGlass	Wildwood
Ⓢ	92	40,6	167,3	135201					
	147,2	40,6	167,3	135202					

36e8 GLASS SIDEBOARD

1353 ●

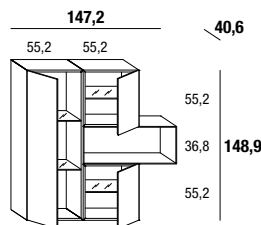
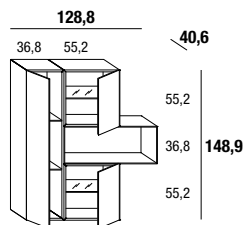
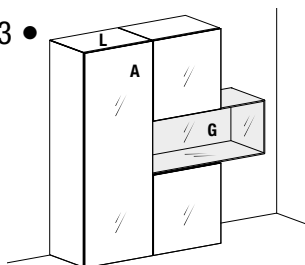

Indicare:

A- colore frontale;

L- colore struttura laccata;

G- finitura struttura vetro: extra-chiaro, fumè grigio o fumè bronzo.

Optional: illuminazione LED sul retro.

Please specify:

A- front colour;

L- lacquered structure colour;

G- glass structure finish: Extra-chiaro, Smoked Grey or Smoked Bronze.

Optional: LED lighting on the reverse.

					Frontale A//A front				
	L//W	P//D	A//H	Codice Code	Laccato Lacquered	Vetro lucido Polished glass	Vetro opaco Matt glass	XGlass lucido o opaco Polished or matt XGlass	Wildwood
Ⓢ	128,8	40,6	148,9	135301					
	147,2	40,6	148,9	135302					

1355 ●

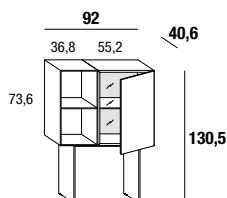
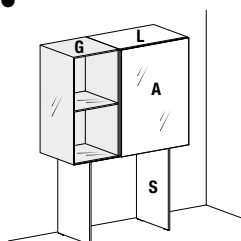

Indicare:

A- colore frontale;

L- colore struttura laccata;

G- finitura struttura vetro: extra-chiaro, fumè grigio o fumè bronzo;

S- finitura sostegni: vetro: extra-chiaro o fumè grigio, metallo: Peltro steel o Titanio steel

Interno con schiena in specchio fumè bronzo.

Optional: illuminazione LED sul retro, illuminazione LED sottobase.

Please specify:

A- front colour;

L- lacquered structure colour;

G- glass structure finish: Extra-chiaro, Smoked Grey or Smoked Bronze;

S- support finish: glass: Extra-chiaro or Smoked Grey, metal: Peltro Steel or Titanio Steel

Inside back in Smoked Bronze mirror.

Optional: LED lighting on the reverse, LED lighting under base.

					Frontale A//A front				
	L//W	P//D	A//H	Codice Code	Laccato Lacquered	Vetro lucido Polished glass	Vetro opaco Matt glass	XGlass lucido o opaco Polished or matt XGlass	Wildwood
Ⓢ	92	40,6	130,5	135501					

36e8 GLASS SIDEBORD

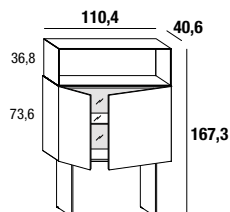
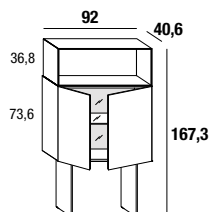
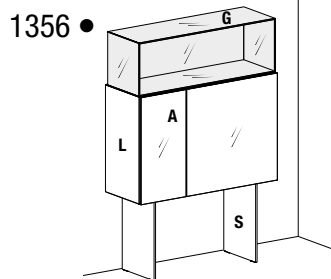

Indicare:

A- colore frontale;
L- colore struttura laccata;
G- finitura struttura vetro: extra-chiaro, fumè grigio o fumè bronzo;
S- finitura sostegni: vetro: extra-chiaro o fumè grigio, metallo: Peltro steel o Titanio steel
Interno con schiena in specchio fumè bronzo.

Optional: illuminazione LED sul retro, illuminazione LED sottobase.

Please specify:

A- front colour;
L- lacquered structure colour;
G- glass structure finish: Extra-chiaro, Smoked Grey or Smoked Bronze;
S- support finish: glass: Extra-chiaro or Smoked Grey, metal: Peltro Steel or Titanio Steel
Inside back in Smoked Bronze mirror.

Optional: LED lighting on the reverse, LED lighting under base.

					Frontale A//A front				
	L//W	P//D	A//H	Codice Code	Laccato Lacquered	Vetro lucido Polished glass	Vetro opaco Matt glass	XGlass lucido o opaco Polished or matt XGlass	Wildwood
Ⓢ	92	40,6	167,3	135601					
	110,4	40,6	167,3	135602					

1357 ●

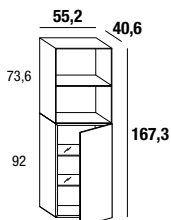
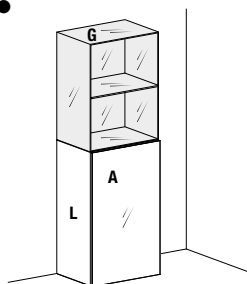

Indicare:

A- colore frontale;
L- colore struttura laccata;
G- finitura struttura vetro: extra-chiaro, fumè grigio o fumè bronzo.
Optional: illuminazione LED sul retro.

Please specify:

A- front colour;
L- lacquered structure colour;
G- glass structure finish: Extra-chiaro, Smoked Grey or Smoked Bronze.
Optional: LED lighting on the reverse.

					Frontale A//A front				
	L//W	P//D	A//H	Codice Code	Laccato Lacquered	Vetro lucido Polished glass	Vetro opaco Matt glass	XGlass lucido o opaco Polished or matt XGlass	Wildwood
Ⓢ	55,2	40,6	167,3	135701					

1358 ●

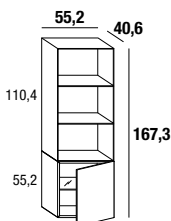
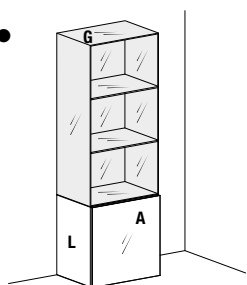

Indicare:

A- colore frontale;
L- colore struttura laccata;
G- finitura struttura vetro: extra-chiaro, fumè grigio o fumè bronzo.
Optional: illuminazione LED sul retro.

Please specify:

A- front colour;
L- lacquered structure colour;
G- glass structure finish: Extra-chiaro, Smoked Grey or Smoked Bronze.
Optional: LED lighting on the reverse.

					Frontale A//A front				
	L//W	P//D	A//H	Codice Code	Laccato Lacquered	Vetro lucido Polished glass	Vetro opaco Matt glass	XGlass lucido o opaco Polished or matt XGlass	Wildwood
Ⓢ	55,2	40,6	167,3	135801					

1359 ●

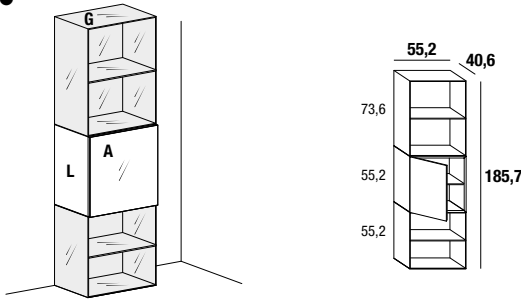

Indicare:
 A- colore frontale;
 L- colore struttura laccata;
 G- finitura struttura vetro: extra-chiaro, fumè grigio o fumè bronzo.
Optional: illuminazione LED sul retro.

Please specify:
 A- front colour;
 L- lacquered structure colour;
 G- glass structure finish: Extra-chiaro, Smoked Grey or Smoked Bronze.
Optional: LED lighting on the reverse.

					Frontale A//A front				
	L//W	P//D	A//H	Codice Code	Laccato Lacquered	Vetro lucido Polished glass	Vetro opaco Matt glass	XGlass lucido o opaco Polished or matt XGlass	Wildwood
Ⓜ	55,2	40,6	185,7	135901					

1360 ●

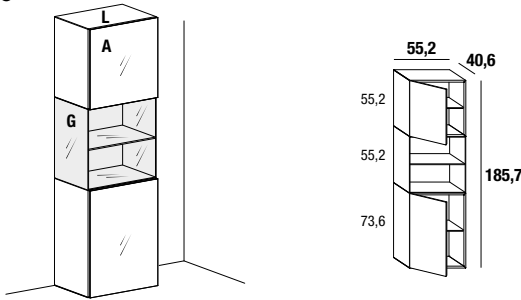

Indicare:
 A- colore frontale;
 L- colore struttura laccata;
 G- finitura struttura vetro: extra-chiaro, fumè grigio o fumè bronzo.
Optional: illuminazione LED sul retro.

Please specify:
 A- front colour;
 L- lacquered structure colour;
 G- glass structure finish: Extra-chiaro, Smoked Grey or Smoked Bronze.
Optional: LED lighting on the reverse.

					Frontale A//A front				
	L//W	P//D	A//H	Codice Code	Laccato Lacquered	Vetro lucido Polished glass	Vetro opaco Matt glass	XGlass lucido o opaco Polished or matt XGlass	Wildwood
Ⓜ	55,2	40,6	185,7	136001					

1361 ●

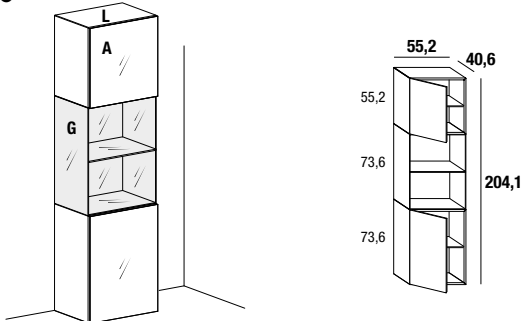

Indicare:
 A- colore frontale;
 L- colore struttura laccata;
 G- finitura struttura vetro: extra-chiaro, fumè grigio o fumè bronzo.
Optional: illuminazione LED sul retro.

Please specify:
 A- front colour;
 L- lacquered structure colour;
 G- glass structure finish: Extra-chiaro, Smoked Grey or Smoked Bronze.
Optional: LED lighting on the reverse.

					Frontale A//A front				
	L//W	P//D	A//H	Codice Code	Laccato Lacquered	Vetro lucido Polished glass	Vetro opaco Matt glass	XGlass lucido o opaco Polished or matt XGlass	Wildwood
Ⓜ	55,2	40,6	204,1	13610					

Ⓜ Previsto fissaggio a parete// To be wall-mounted

36e8 GLASS SIDEBORD

1362 ●

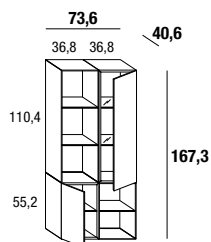
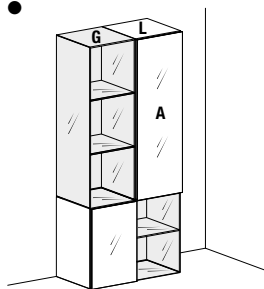

Indicare:

A- colore frontale;

L- colore struttura laccata;

G- finitura struttura vetro: extra-chiaro, fumè grigio o fumè bronzo.

Optional: illuminazione LED sul retro.

Please specify:

A- front colour;

L- lacquered structure colour;

G- glass structure finish: Extra-chiaro, Smoked Grey or Smoked Bronze.

Optional: LED lighting on the reverse.

					Frontale A//A front				
L//W	P//D	A//H	Codice Code	Laccato Lacquered	Vetro lucido Polished glass	Vetro opaco Matt glass	XGlass lucido o opaco Polished or matt XGlass	Wildwood	
73,6	40,6	167,3	136201						

1363 ●

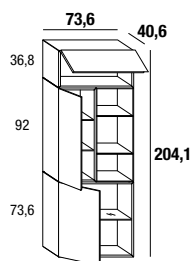
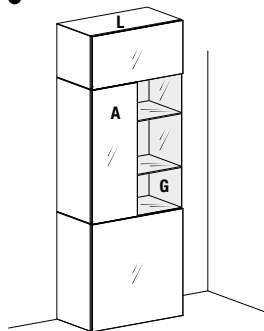

Indicare:

A- colore frontale;

L- colore struttura laccata;

G- finitura struttura vetro: extra-chiaro, fumè grigio o fumè bronzo.

Optional: illuminazione LED sul retro.

Please specify:

A- front colour;

L- lacquered structure colour;

G- glass structure finish: Extra-chiaro, Smoked Grey or Smoked Bronze.

Optional: LED lighting on the reverse.

					Frontale A//A front				
L//W	P//D	A//H	Codice Code	Laccato Lacquered	Vetro lucido Polished glass	Vetro opaco Matt glass	XGlass lucido o opaco Polished or matt XGlass	Wildwood	
73,6	40,6	204,1	136301						

Laccato

EN Lacquered / ES Lacado / FR Laqué / DE Lackiert

Solidità, rigore, rassicurante perfezione formale e accessibilità: il laccato è una tavolozza creativa in cui funzionalità e colori realizzano la superficie visiva del design. La laccatura è realizzata con prodotti all'acqua privi di solventi evitando così l'emissione di sostanze organiche volatili nocive nell'ambiente.

Solidity, rigour, reassuring formal perfection and accessibility: lacquer is a creative palette where functionality and colour create visual surfaces with a design sensibility. LAGO lacquer is made with solvent-free, water-based products, thus avoiding the emission of noxious, volatile organic substances in the environment.

Solidez, rigor, tranquilizadora perfección formal y accesibilidad: el lacado es una paleta creativa en donde la funcionalidad y los colores hacen realidad la superficie visual del diseño. El proceso de lacado se realiza con productos acuosos que no contienen solventes, evitando así la emisión al medio ambiente de sustancias orgánicas volátiles nocivas.

Solidité, rigueur, rassurante perfection formelle et accessibilité: le laqué est une palette créative dans laquelle fonctionnalités et couleurs créent la surface visuelle du design. La finition laquée est réalisée avec des produits hydriques sans solvants qui évitent l'émission de composés organiques volatils nocifs pour l'environnement.

Haltbarkeit, Geradlinigkeit, formelle beruhigende Perfektion: Die Farblacke sind Teil einer kreativen Farbpalette, in der Funktionalität und Farben die visuelle Oberfläche des Designs verwirklichen. Der Lackanstrich wird mit Produkten durchgeführt, die Wasser enthalten und lösungsmittelfrei sind, um so das Entweichen von schädlichen, organischen Stoffen in die Umwelt zu vermeiden.



La rappresentazione dei colori ha valore indicativo / The colour representation is indicative / La representación de los colores tiene valor indicativo / La représentation des couleurs est indicative / Die abgebildeten Farben können vom Original abweichen.

Vetro lucido

EN Polished glass / ES Cristal brillante / FR Verre brillant / DE Glas poliert

Il vetro LAGO cattura lo sguardo con una nuova esperienza del colore, reso vivo, profondo e mutevole al variare delle condizioni della luce. Rigorosamente perfetto, mantiene inalterata attraverso il tempo la propria bellezza. Il vetro ha doti intrinseche di igienicità, facile da pulire in quanto non assorbe lo sporco e le macchie e temperato, ovvero trattato termicamente per ottenere una elevata resistenza all'urto, al graffio e al calore. Viene verniciato all'acqua ed è un materiale riciclabile al 100%.

LAGO glass captures the eye with a new experience of colour, made brilliant, deep and changeable according to light conditions. Rigorously perfect, it preserves its beauty unaltered over time. LAGO glass has intrinsic hygienic properties, it is easy to clean since it does not absorb dirt or stains and it is tempered, that is to say temperature-treated in order to obtain higher resistance to shocks, scratches and heat. It is painted with water-based colour and is a 100% recyclable material.

El vidrio LAGO cautiva la mirada con una nueva forma de vivir el color, vuelto vivo, profundo y cambiante al variar las condiciones de luz. Rigurosamente perfecto, mantiene inalterada en el tiempo su belleza. El vidrio tiene características intrínsecas que lo hacen un material limpio: es fácil de lavar ya que no absorbe la suciedad ni las manchas, y con el templado es tratado térmicamente para obtener una alta resistencia a los golpes, las ralladuras y el calor. Está barnizado al agua y es un material 100% reciclable.

Le verre LAGO accroche le regard avec une nouvelle expérience de la couleur, rendue vive, profonde et changeante en fonction des variations lumineuses. Rigoureusement parfait, il conserve une beauté inaltérée à travers le temps. Le verre a des qualités hygiéniques intrinsèques: il est facile à nettoyer, car il n'absorbe ni la saleté ni les taches, et est trempé, c'est-à-dire traité thermiquement pour renforcer sa résistance aux chocs, aux rayures et à la chaleur. Verni à l'eau, ce matériau est 100 % recyclable.

Das LAGO-Glas lenkt den Blick mit einem neuen Farberlebnis auf sich, das sich Stunde um Stunde mit den Verhältnissen des Lichts als lebendig, tiefgründig und veränderbar erweist. Auf perfekte Art und Weise behält es strengstens seine Schönheit, die sich im Laufe der Zeit kein bisschen verändert. Das Glas verfügt über die einmalige Gabe der Reinheit. Es ist leicht zu reinigen, da es keinen Schmutz und keine Flecken aufnimmt; es ist für eine höhere Resistenz Stößen, Kratzern und Hitze gegenüber temperiert bzw. wärmebehandelt. Es wird mit Farben auf Wasserbasis gestrichen und ist ein 100%ig recyclefähiges Material.



La rappresentazione dei colori ha valore indicativo / The colour representation is indicative / La representación de los colores tiene valor indicativo / La représentation des couleurs est indicative / Die abgebildeten Farben können vom Original abweichen.

Vetro opaco

EN Matt glass / ES Cristal mate / FR Verre mat / DE Glas satiniert

Grazie a un processo di acidatura delle lastre, il vetro opaco LAGO crea nuovi linguaggi compositivi mescolando la perfezione tattile e formale di questo materiale con un effetto visivo sorprendente. Più delicato del vetro lucido ha doti di igienicità ed è temperato, ovvero trattato termicamente per ottenere una elevata resistenza all'urto, al graffio e al calore. Il vetro viene verniciato all'acqua ed è un materiale riciclabile al 100%.

Thanks to an acidizing process, LAGO opaque glass creates new compositional languages, mixing the tactile and formal perfection of this material with a surprising visual effect. More delicate than shiny glass, it has hygienic properties and is tempered, that is to say temperature-treated in order to obtain higher resistance to shocks, scratches and heat. LAGO opaque glass is painted with water-based colour and is a 100% recyclable material.

Gracias a un proceso de acidificación de las láminas, el vidrio opaco LAGO crea nuevos lenguajes compositivos mezclando la perfección táctil y formal de este material con un efecto visual sorprendente. Más delicado que el vidrio brillante, tiene cualidades higiénicas y está templado, es decir tratado térmicamente para obtener una alta resistencia a los golpes, las ralladuras y el calor. El vidrio está barnizado al agua y es un material 100% reciclable.

Grâce à un procédé de traitement à l'acide des plaques, le verre opaque LAGO crée de nouveaux langages de composition, en mêlant la perfection tactile et formelle de ce matériau avec un effet visuel saisissant. Plus délicat que le verre poli, il est hygiénique et trempé, c'est-à-dire traité thermiquement pour une meilleure résistance au chocs, aux rayures et à la chaleur. Ce verre verni à l'eau est un matériau 100 % recyclable.

Dank einer Säurebehandlung der Scheiben, erfindet das Mattglas von LAGO eine neue Kompositionssprache, indem es die tastbare und formale Perfektion dieses Materials mit einem offensichtlichen, erstaunlichen Effekt vereint. Es ist delikater als transparentes Glas und verfügt über hygienische Eigenschaften; ist für eine höhere Resistenz Stößen, Kratzern und Hitze gegenüber temperiert bzw. wärmebehandelt. Es wird mit Farben auf Wasserbasis gestrichen und ist ein 100%ig recyclefähiges Material.



La rappresentazione dei colori ha valore indicativo / The colour representation is indicative / La representación de los colores tiene valor indicativo / La représentation des couleurs est indicative / Die abgebildeten Farben können vom Original abweichen.

Vetro Metal lucido e opaco

^{EN} Polished and matt Metal Glass / ^{ES} Cristal Metal brillante es mate / ^{FR} Verre Métal brillant et mat / ^{DE} Glas Metal poliert und satiniert

Tre colorazioni dai riflessi metallici caldi e cangianti avvolgono le superfici in modo uniforme, donando dinamismo e luminosità al prodotto nelle diverse finiture, lucida e opaca. Colori vivi che producono eleganti effetti visivi al variare della luce naturale e domestica. Realizzati con prodotti all'acqua privi di solventi, garantiscono igienicità e resistenza nel tempo grazie alle proprietà intrinseche del vetro.

Three shimmering metallic colours dominate the surface evenly, creating a bright, warm and dynamic look, available in a range of matt and polished finishes. Vivid colours create elegant visuals as the light changes both indoors and outdoors. Produced using solvent-free, water-based products, your furniture is hygienic and durable over time, thanks to the intrinsic qualities of glass.

Tres coloraciones de reflejos metálicos cálidos y cambiantes envuelven las superficies de manera uniforme, dando dinamismo y luminosidad al producto en los diferentes acabados brillo y mate. Colores vivos que producen elegantes efectos visuales al variar la luz natural y doméstica. Realizados con productos al agua sin disolventes, garantizan higiene y resistencia a lo largo del tiempo gracias a las propiedades intrínsecas del cristal.

Trois coloris aux reflets métalliques chauds et chatoyants enveloppent les surfaces de manière uniforme, tout en donnant dynamisme et luminosité au produit dans les différentes finitions, brillantes et mates. Des couleurs vives qui produisent d'élégants effets visuels selon la variation de la lumière naturelle et domestique. Réalisés avec des produits à l'eau sans solvants, ils garantissent hygiène et résistance dans le temps grâce aux propriétés intrinsèques du verre.

Drei Farben mit warmen, changierenden Metallic-Reflexen umhüllen die Oberflächen gleichmäßig und verleihen dem Produkt in den verschiedenen Ausführungen – glänzend und matt – Dynamik und Helligkeit. Lebendige Farben, die bei wechselndem natürlichem und häuslichem Licht elegante visuelle Effekte erzeugen. Sie werden mit lösungsmittelfreien Produkten auf Wasserbasis hergestellt und garantieren dank der charakteristischen Eigenschaften von Glas Hygiene und Haltbarkeit.

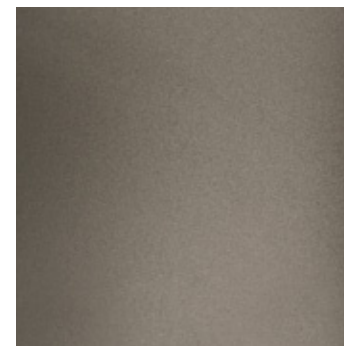

CHAMPAGNE METAL

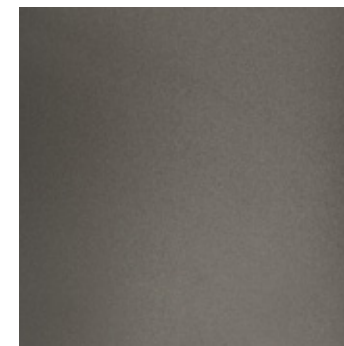

PIOMBO METAL

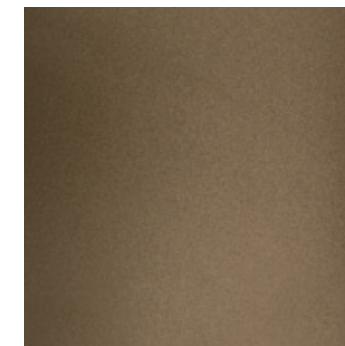

TUNDRA METAL

XGlass lucido e opaco

EN Polished and matt XGlass / ES XGlass brillante es mate / FR XGlass brillant et mat / DE XGlass poliert und satiniert

La rivoluzione tecnologica sta accelerando i processi di innovazione anche nel campo dei materiali, offrendo opportunità incredibili. Grazie alla digital print XGlass coniuga le qualità di un materiale nobile e prezioso come il vetro alle emozioni di molteplici materiali. Le diverse finiture, lucida e opaca, aumentano poi l'empatia con il materiale stesso. Una raffinata continuità di pattern connota le superfici dei prodotti. XGlass è una strategia innovativa anche per poter ridurre in più casi l'impatto ambientale e migliorare quello sociale.

The technological revolution is speeding up innovation and offering incredible opportunities, including in the field of materials. Using digital printing technology, XGlass combines the fine qualities of glass with the emotion of a whole range of other materials. The different finishes, available in glossy and mat, increase empathy with the material itself and a refined continuous pattern defines the surface of each piece. XGlass is also an innovative solution for reducing environmental impact in many cases and improving the social one.

La révolution technologique accélère les processus d'innovation même dans le domaine des matériaux et ouvre la voie à d'incroyables opportunités. Grâce à l'impression numérique, XGlass combine les qualités d'un matériau noble et précieux comme le verre aux émotions de plusieurs matériaux. Les diverses finitions, brillante et opaque, intensifient l'empathie avec le matériau lui-même. Cette continuité raffinée de motifs caractérise les surfaces des produits. XGlass est également une stratégie innovante qui permet de réduire, dans de nombreux cas, l'incidence environnementale et d'améliorer l'impact social.

La revolución tecnológica está acelerando los procesos de innovación en el campo de los materiales, ofreciendo oportunidades increíbles. Gracias a la impresión digital, XGlass conjuga las cualidades de un material noble y preciado como el cristal con las emociones de múltiples materiales. Los diferentes acabados, brillo y mate, aumentan también la empatía con el material mismo. Una elegante continuidad de estampados distinguen las superficies de los productos. XGlass es una estrategia innovadora también para poder reducir en más casos el impacto ambiental y mejorar el social.

Die technologische Revolution beschleunigt Innovationsprozesse auch im Bereich der Materialien und bietet unglaubliche Möglichkeiten. Dank des Digitaldrucks verbindet XGlass die Eigenschaften eines edlen und kostbaren Materials wie Glas mit den Emotionen vieler Materialien. Die verschiedenen Ausführungen, die glänzend und matt erhältlich sind, sorgen für noch mehr Begeisterung. Ein raffinierter Übergang der Muster auf der Oberflächen gibt den Produkte ihren besonderen Charakter. XGlass ist ein innovative Instrument zur Verringerung der Umweltbelastung und zur Verbesserung der sozialen Auswirkungen.

MARBLE XGLASS

Gamma completa - Complete range - Amplia gama - Gamme complète - Umfassende Palette

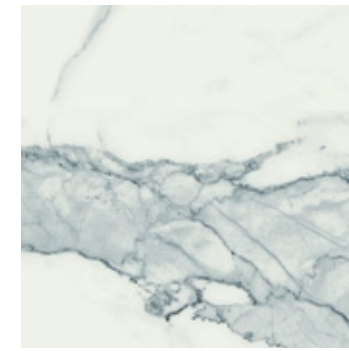

STATUARIO



PAONAZZO



CALACATTA GOLD



ONICE GRIGIO

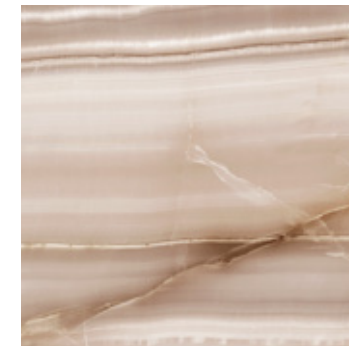

ONICE

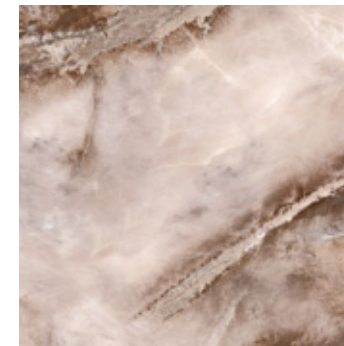

ALABASTRO

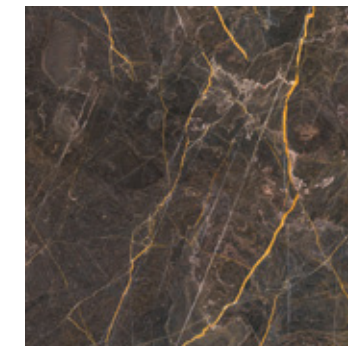

PORT SAINT LAURENT

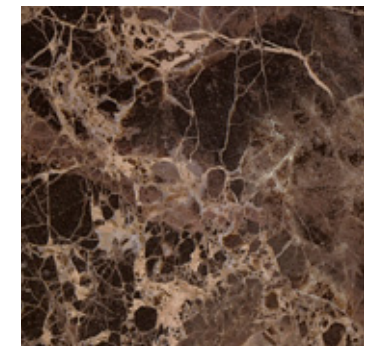

EMPERADOR

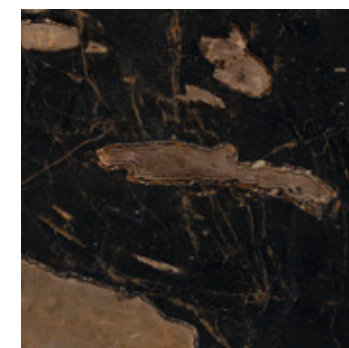

GEODE

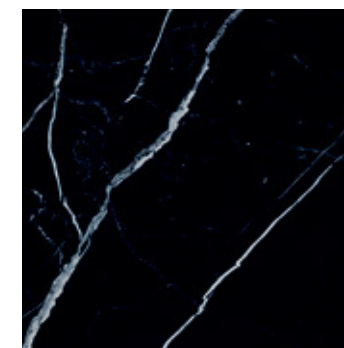

MARQUINA

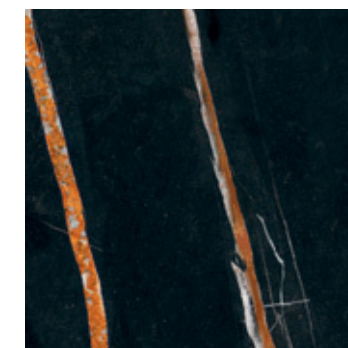

SAHARA NOIR

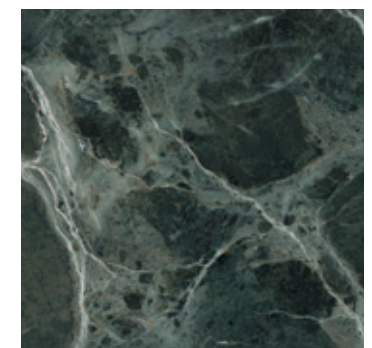

VERDE ALPI

MARBLE XGLASS

Scala 1:3 - Scale 1:3 - Escala 1:3 - Échelle 1:3 - Maßstab 1:3

3 m

2 m

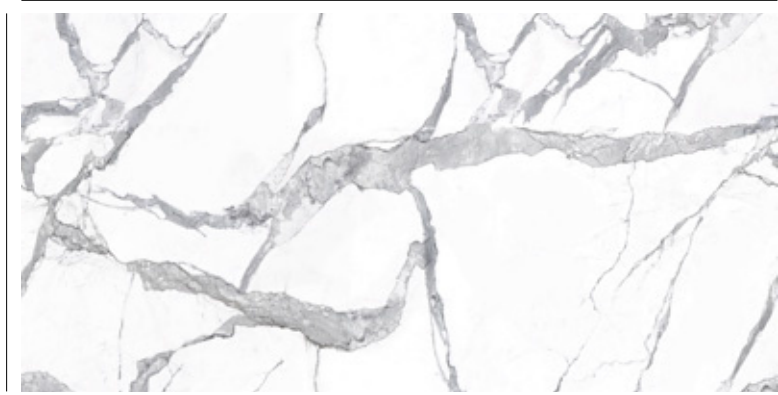

STATUARIO



PAONAZZO

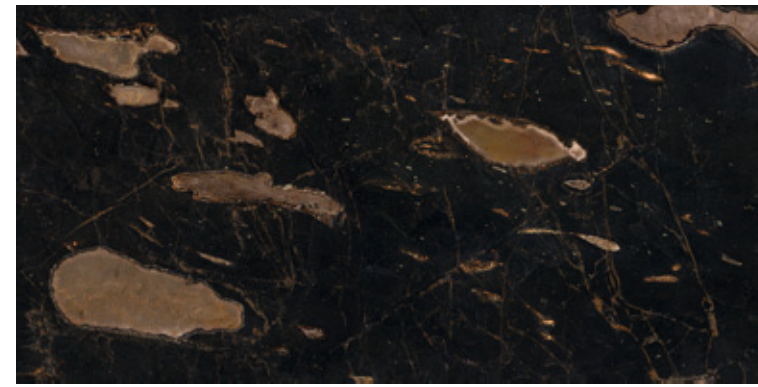

GEODE



MARQUINA



CALACATTA GOLD

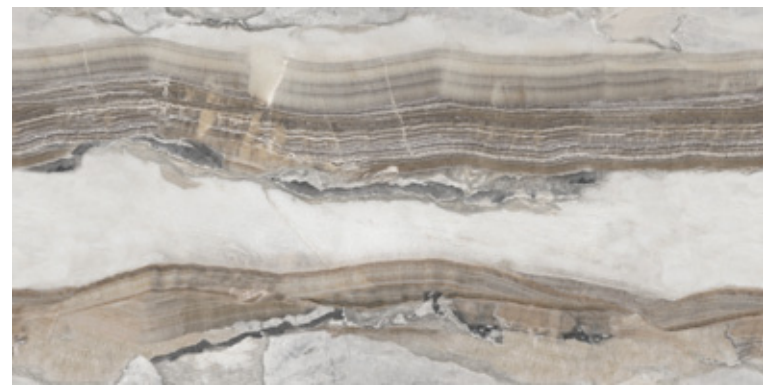

ONICE GRIGIO

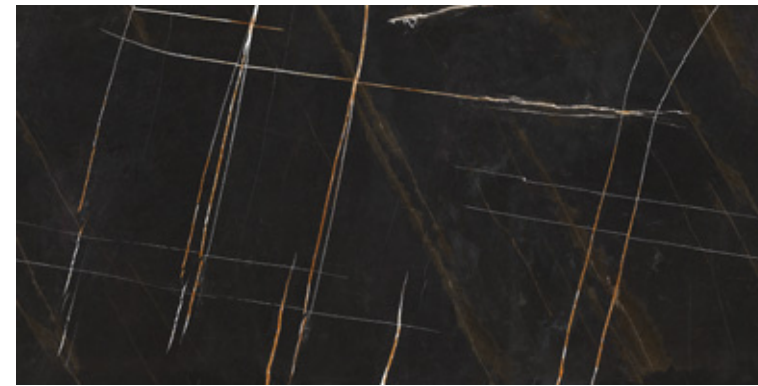

SAHARA NOIR

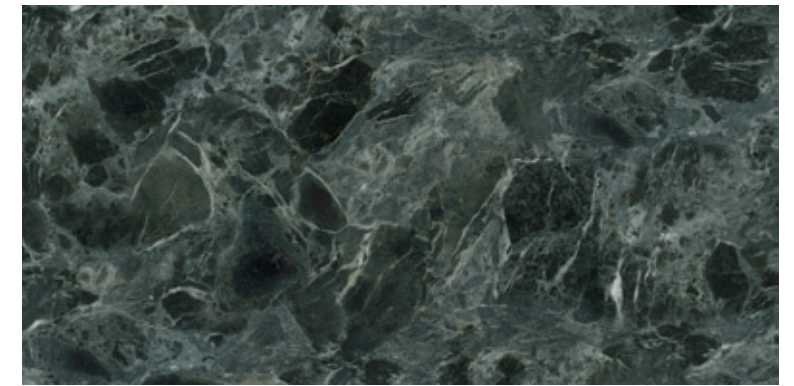

VERDE ALPI

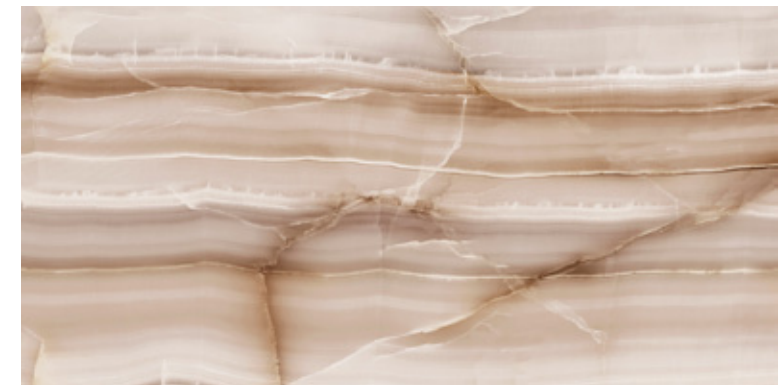

ONICE



ALABASTRO

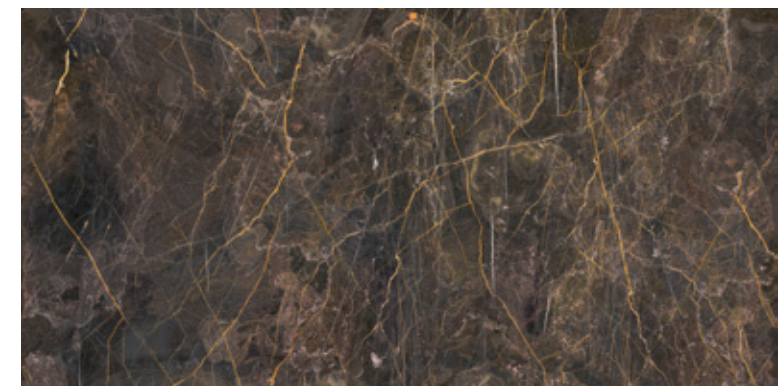

PORT SAINT LAURENT



EMPERADOR

METAL XGLASS



TITANIO

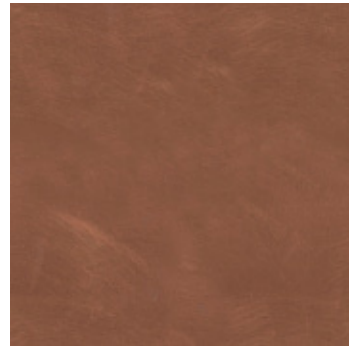

RAME



ORO



BRONZO



PELTRO

HOME COUTURE XGLASS

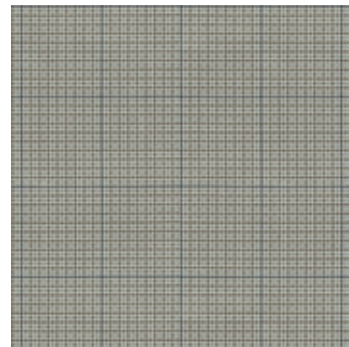

KISS WOOL

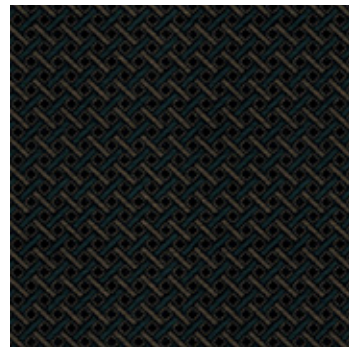

POP PANTS

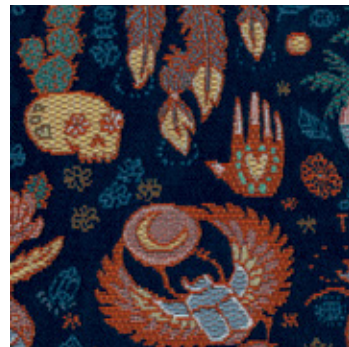

ART & CRAFT

ANIMAL ZERO XGLASS*

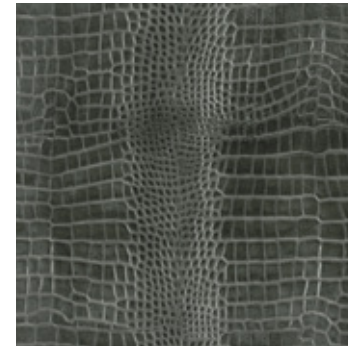

COCCODRILLO VERDE

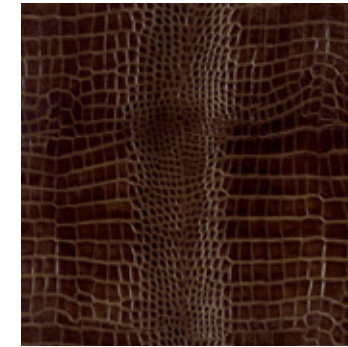

COCCODRILLO MARRONE

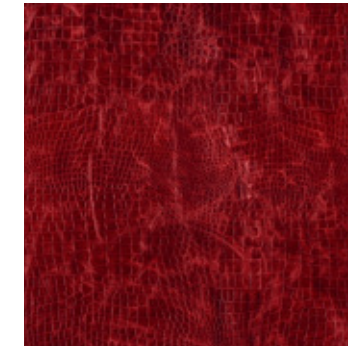

COBRA ROSSO

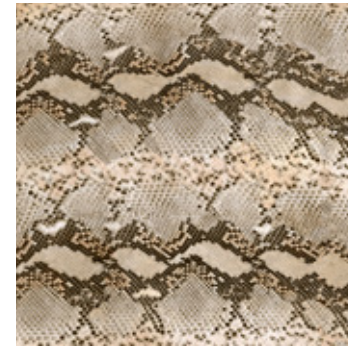

PITONE

**Disponibile solo nella versione lucida. / Available only in the polished version. / Disponible sólo en la versión brillante. / Disponible uniquement en version brillant. / Nur in der poliert Version erhältlich.*

WOOD XGLASS

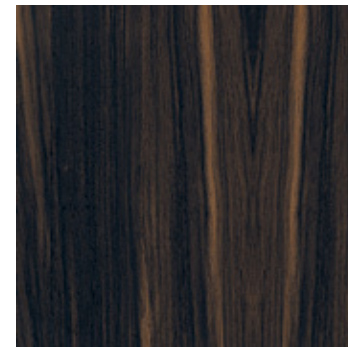

EBANO MACASSAR

Wildwood

Calore, ospitalità, senso del tempo, il legno sa essere primordiale ambasciatore di verità e, allo stesso tempo, di un lusso raffinato e tattile. Realizzato a partire da legno di rovere piallato a mano, il Wildwood è sottoposto a una lavorazione artigianale che ne esalta le naturali imperfezioni. I nodi e le fessure sono stuccati con prodotti speciali ad alta resistenza e una verniciatura protettiva limita la permeabilità della superficie ai liquidi e alle macchie.

Warmth, hospitality, a sense of time: wood is a primordial ambassador of truth and, at the same time, a refined, tactile luxury. Made with hand-planed oak, is artisanally processed to enhance its natural imperfections. The knots and fissures are stuccoed with special highly resistant products and a protective varnish increases the water and stain resistance of the surfaces.

Calor, hospitalidad, sentido del tiempo; la madera sabe ser primordial embajadora de la verdad y, al mismo tiempo, de un lujo refinado y táctil. Realizada a partir de madera de roble cepillada a mano, la madera Wildwood es trabajada artesanalmente resaltando sus imperfecciones naturales. Los nudos y las hendiduras son enmasilladas con productos especiales de alta resistencia y un barnizado protector reduce la permeabilidad de la superficie a los líquidos y las manchas.

Chaleur, hospitalité, sens du temps, le bois sait être le principal ambassadeur de la vérité et, parallèlement, d'un luxe raffiné et tactile. Fabriqué à partir de bois de chêne raboté à la main, Wildwood est un bois travaillé artisanalement: ses imperfections naturelles sont donc exaltées. Les nœuds et les fissures sont stuqués avec des produits spéciaux à haute résistance et la perméabilité de sa surface aux liquides et aux taches est limitée par un vernis protecteur.

Wärme, Gastfreundlichkeit, Zeitgefühl. Holz kann wirklich als der Ur-Botschafter der Wahrheit angesehen und zugleich als ausgearbeiteter und tastbarer Luxus eingesetzt werden. Es entsteht aus Eichenholz, das per Hand gehobelt wird. Das Wildwood wird einer traditionellen Bearbeitung per Hand unterworfen, die die natürliche Unvollkommenheit dieses Holzes rühmt und hervorhebt. Die Baumknoten und -ritzen sind mit speziellen Produkten für eine hohe Festigkeit gekittet. Ein Schutzlack versiegelt die Oberfläche, wodurch diese für Flüssigkeiten und Flecken undurchlässig werden.



CHIARO



NATURALE



TABACCO

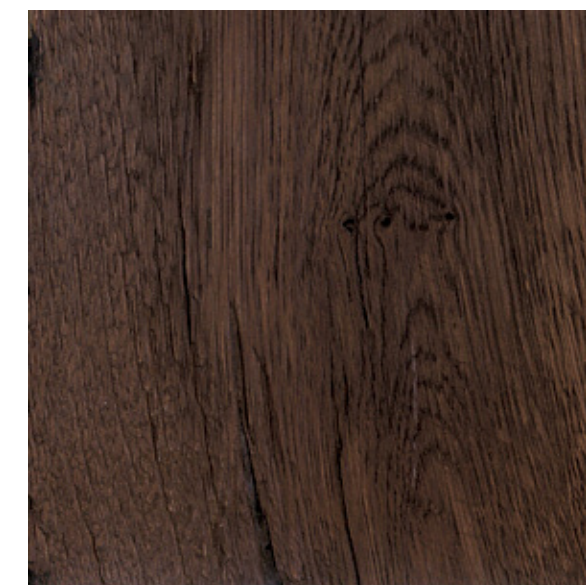

SCURO

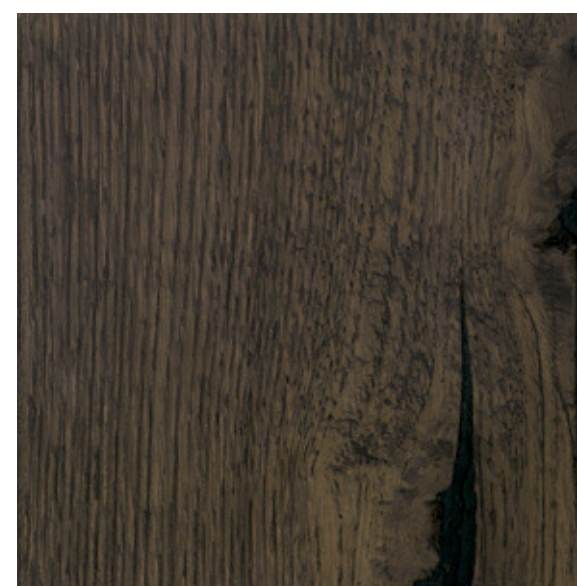

GRIGIO

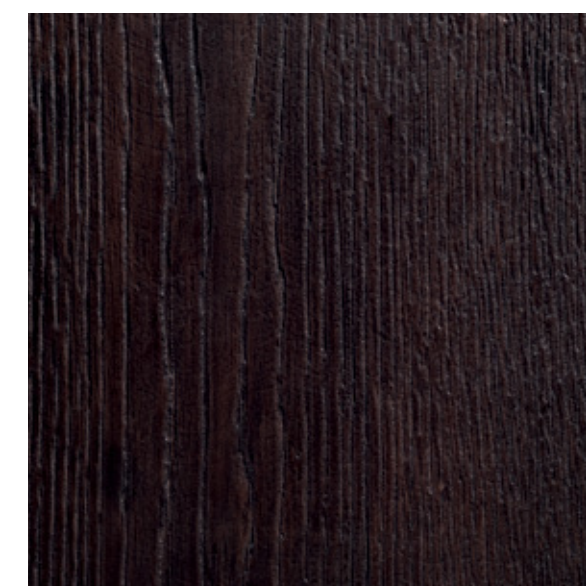

NERO

Vetro

EN Glass / ES Cristal / FR Verre / DE Glas

Un materiale estremamente affascinante e funzionale. Sinonimo di leggerezza, il vetro dialoga con la luce per dare vita a riflessi vivaci e cangianti, che donano eleganza e modernità a tutto l'interior. Utilizziamo vetro trasparente extra-chiaro in modo da avere quella purezza che garantisce trasparenza assoluta. I vetri fumè invece hanno un'anima più misteriosa e ricca di fascino. Tutti i nostri vetri sono temperati, infatti grazie al trattamento di tempra a 700° aumenta esponenzialmente la propria resistenza a carichi ed urti per una sicurezza totale.

A fascinating and functional material. Synonymous with lightness, glass creates intense reflections that change with the light, giving an elegant, modern feel to the interiors. We use extra-clear glass for an ultra-pure finish that guarantees absolute transparency. Our smoked glass finishes create an air of mystery and have enigmatic appeal. All the glass we use is tempered, undergoing treatment at 700°C to increase its resistance to loads and impact exponentially, which makes it 100% safe.

Un material extremadamente fascinante y funcional. Sinónimo de ligereza, el cristal dialoga con la luz para dar vida a reflejos vivos e irisados, que regalan elegancia y modernidad a todo el diseño de interiores. Utilizamos cristal transparente extraclaro para obtener la pureza que garantiza transparencia absoluta. Los cristales fumè, en cambio, tienen un alma más misteriosa y llena de encanto. Todos nuestros cristales son templados, gracias al tratamiento de temple a 700° aumenta exponencialmente su resistencia a la carga y los golpes para lograr una seguridad total.

Un matériau extrêmement fascinant et fonctionnel. Synonyme de légèreté, le verre dialogue avec la lumière pour donner vie à des reflets vifs et irisés qui donnent de l'élégance et de la modernité à tout l'intérieur. Nous utilisons du verre transparent extra-clair afin d'avoir la pureté qui garantit une transparence absolue. Les verres fumés ont, en revanche, une âme plus mystérieuse et plus fascinante. Tous nos verres sont trempés ; en effet, grâce au traitement de trempé à 700°, sa résistance aux charges et aux chocs augmente exponentiellement pour une sécurité totale.

Ein äußerst faszinierendes und funktionales Material. Als Synonym für Leichtigkeit steht Glas im Dialog mit Licht und erzeugt so lebendige, schillernde Reflexe, die dem gesamten Interieur Eleganz und Modernität verleihen. Wir verwenden extraklares durchsichtiges Glas, um die Reinheit zu erreichen, die absolute Transparenz garantiert. Rauchglas hingegen hat eine geheimnisvollere Ausstrahlung voller Faszination. Alle unsere Gläser sind gehärtet. So wird dank der thermischen Vorspannung bei 700° ihre Widerstandsfähigkeit gegen Belastungen und Stöße exponentiell erhöht - für absolute Sicherheit.



EXTRA-CHIARO



FUMÈ GRIGIO



FUMÈ BRONZO

La rappresentazione dei colori ha valore indicativo / The colour representation is indicative / La representación de los colores tiene valor indicativo
La représentation des couleurs est indicative / Die abgebildeten Farben können vom Original abweichen.